

**DENSO**

**Barcode Handy Terminal**

**BHT-500B**

**User's Manual**



8 9 0 1 2 3 4 5 6 7 8 9 0

# Preface

Thank you for using the BHT-500B DENSO WAVE Barcode Handy Terminal.

The BHT-500B is a barcode handy terminal model setting new industrial standards, and features the industry's highest level of scanning performance and advanced scanning (CCD method).

Please read this manual thoroughly prior to operation to ensure full use of the product's functionality, and store safely in a convenient location for quick reference even after reading.

## Liability Limitations

- DENSO WAVE INCORPORATED does not assume any product liability (including damages for lost profits, interruption of operations, or the loss of business-related information) arising out of, or in connection with, the use of, or inability to use the BHT system software or related manuals.
- DENSO WAVE INCORPORATED ("DENSO WAVE") takes reasonable precautions to ensure its products do not infringe upon any patents or other intellectual property rights of other(s), however, DENSO WAVE cannot be responsible for any patent or other intellectual property right infringement(s) or violation(s) arising from any of the following.
  - 1) The use of DENSO WAVE's products in connection or in combination with other components, products, devices, data processing systems or software not supplied by DENSO WAVE.
  - 2) The use of DENSO WAVE's products in a manner for which they were not intended nor designed.
  - 3) The modification of DENSO WAVE's products by parties other than DENSO WAVE.
- If it is judged by DENSO WAVE INCORPORATED that malfunction of the product is due to the product having been dropped or subjected to impact, repairs will be made at a reasonable charge even within the warranty period.

The BHT-500B models are designed in the same way except for the interface differences shown in the table below. In this manual, operations common for all models are explained unless otherwise stated.

|           | IrDA Interface | Connector Interface | Wireless Communication |
|-----------|----------------|---------------------|------------------------|
| BHT-503B  | •              | •                   | —                      |
| BHT-504BW | •              | •                   | •                      |

Product names of the handy terminal which is the object of the regulation of these specifications are classified based on its memory capacity installed.

| Product Name | Flash Memory Capacity |
|--------------|-----------------------|
| BHT-503B     | 8 MB                  |
| BHT-504BW    | 16 MB                 |

# Customer Registration and Inquiries

## Customer Registration

To allow us to provide our customers with comprehensive service and support, we request that all customers complete a Member Registration Form. Registered members will be offered the following privileges.

- The latest upgrade information
- Free exhibition and event information for new products
- Free Web-information service "QBdirect".

### QBdirect Service Contents

|                                  |  |
|----------------------------------|--|
| Information search service (FAQ) | Offers detailed information on each product.   |
| Download service                 | Offers downloads of repair modules for the latest BHT Series systems or software, and sample programs. |
| E-mail inquiries                 | Product related queries can be sent in by e-mail.  |

\* Please note that these privileges may be subject to change without prior notice.

### – How to Register

Access the URL below and follow the instructions provided.

<http://www.qbdirect.net>

## Inquiries

### – Technical Inquiries (QBdirect)

- BHT product programming method
- Product setup method, usage
- Other technical questions

Inquires relating to the above can be made at our exclusive Web site for registered users (QBdirect).

Access the link below to log on or register.

<http://www.qbdirect.net>

# About this Manual

- Due to improvements and so on, the content of this manual may be subject to change without prior notice.
- The reproduction or duplication of the whole or part of this manual is strictly prohibited without prior consent.
- Every attempt has been made to ensure that the content of this manual is thorough and up to date, however, we kindly ask that any questionable content, mistakes, or omissions be reported to DENSO WAVE.
- The copyright for this User's Manual belongs to DENSO WAVE INCORPORATED.

## Manual Composition

This manual is made up of the following 9 chapters.

### **Chapter 1      Outline**

Describes the BHT system and provides an overall outline of the BHT.

### **Chapter 2      BHT Preparation**

Describes information required by the user and procedures that must be performed prior to commencing operation.

### **Chapter 3      Basic Operation**

Describes basic operations performed by the operator and how to make basic changes to settings such as the beeper volume.

### **Chapter 4      System Operation**

Describes how to initialize and update the system, start up a user program, and operate System Mode.

### **Chapter 5      Communication**

Describes interfaces and communication specifications.

### **Chapter 6      Maintenance**

Describes battery cartridge replacement and daily procedures for taking care of the BHT.

### **Chapter 7      Error Messages**

Describes causes and countermeasures for error messages expected to occur during basic operation.

### **Chapter 8      Specifications**

Describes specifications for hardware, readable barcodes, and interfaces.

### **Appendices-1   CU-500 Specifications (Option)**

Describes the main specifications for the CU-500 Series (option).

### **Appendices-2   When File Transfer is Not Possible Using the Transfer Utility**

Describes causes and countermeasures when unable to transfer files.

## Viewing this Manual

### - About the Bookmark

The PDF Bookmark function can be used to jump to the Contents page.

<Procedure>

- (1) Click the "Bookmark" tab.
- (2) Click "+" to search for the desired item.
- (3) Click the item to be read.

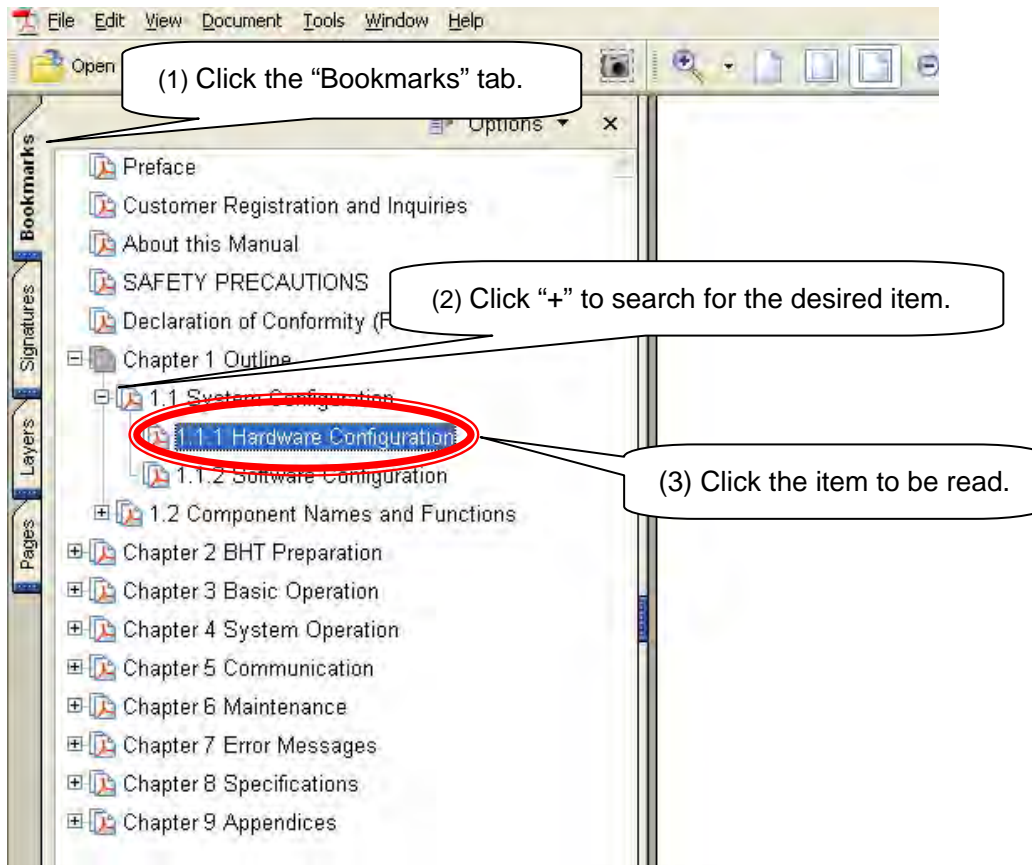

### - Searching by Word

The PDF search function can be used to jump to the target page by entering words or characters related to the item being searched.

- (1) Click the Search icon. (Or select "Edit" – "Search".)
- (2) Enter the word(s) or character(s) to be searched for.
- (3) Click [Search].

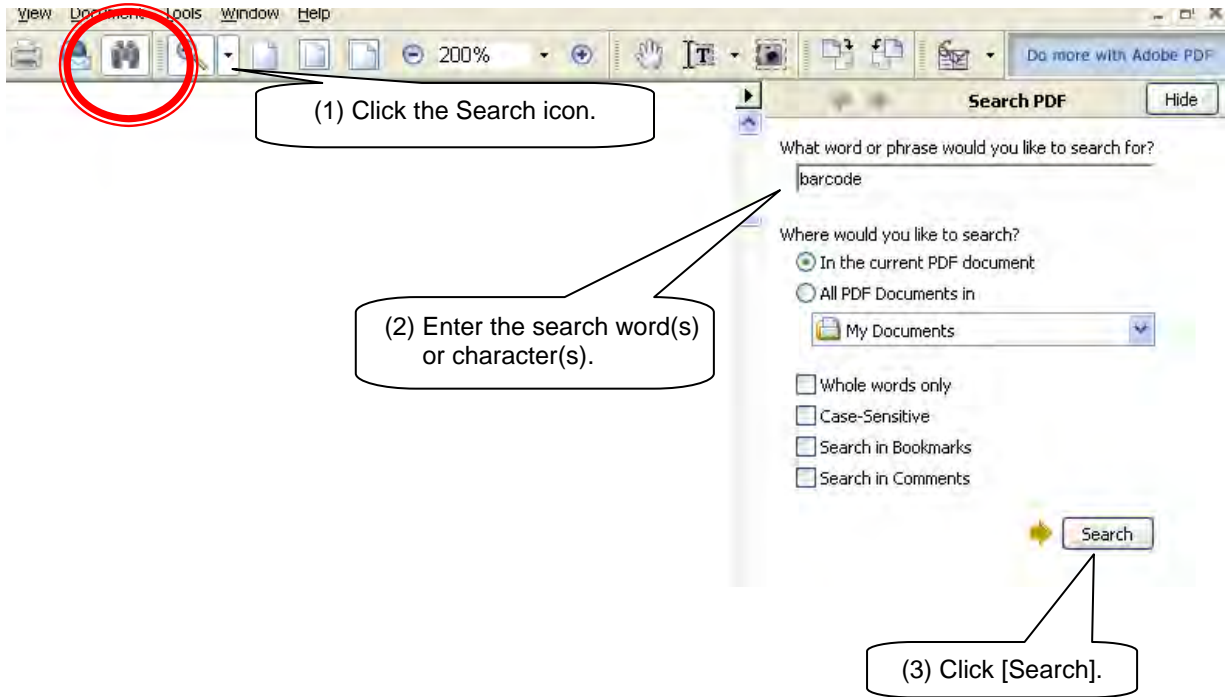

### <Search Results Example>

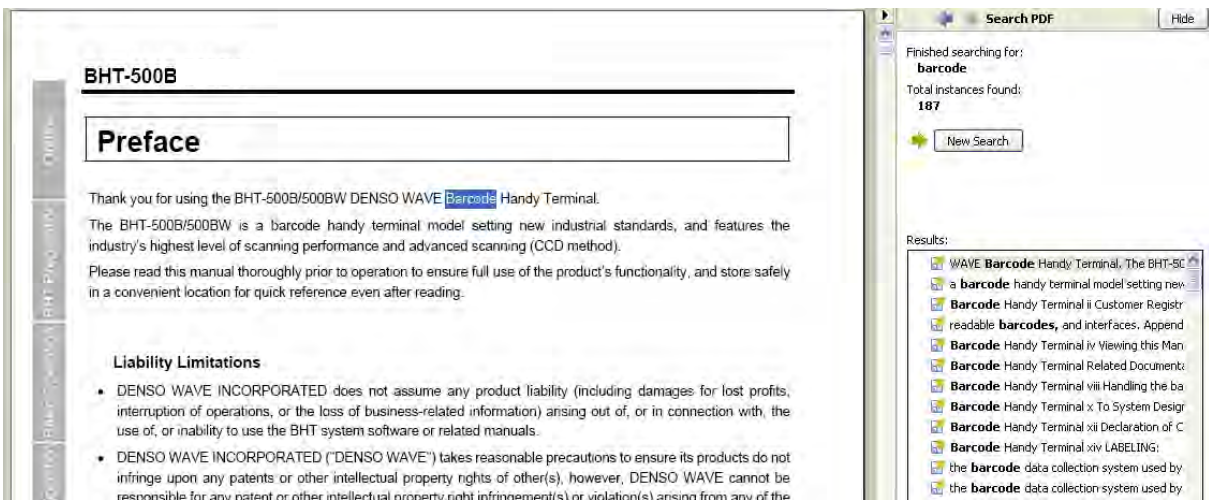

## Related Documentation



- BHT-BASIC Programmer's Manual (BHT-500 Series)  
This is an instruction manual used to create handy terminal programs with BHT-BASIC.  
This manual can be found in the BHT-BASIC Compiler CD-ROM.  
This manual can also be downloaded from the DENSO WAVE member's Web site (QBdirect).
- BHT-BASIC 4.0 Transfer Utility User's Guide  
This is an instruction manual for software relating to data transfer between the computer and BHT-500 and comes bundled with the BHT-BASIC 4.0 Transfer Utility.  
This manual can also be downloaded from the DENSO WAVE member's Web site (QBdirect).

# SAFETY PRECAUTIONS



**Be sure to observe all these safety precautions.**

- Please READ through this manual carefully. It will enable you to use the BHT and CU correctly.
- Always keep this manual nearby for speedy reference.

Strict observance of these warnings and cautions is a MUST for preventing accidents that could result in bodily injury and substantial property damage. Make sure you fully understand all definitions of these terms and symbols given below before you proceed to the text itself.

|   |                |  |
|---|----------------|--|
|  | <b>WARNING</b> | Alerts you to those conditions that could cause serious bodily injury or death if the instructions are not followed correctly.                     |
|  | <b>CAUTION</b> | Alerts you to those conditions that could cause minor bodily injury or substantial property damage if the instructions are not followed correctly. |



## Meaning of Symbols

|   |  |
|---|--|
|   | A triangle (△) with a picture inside alerts you to a warning of danger. Here you see the warning for electrical shock.   |
|  | A diagonal line through a circle (⊘) warns you of something you should not do; it may or may not have a picture inside. Here you see a screwdriver inside the circle, meaning that you should not disassemble. |
|  | A black circle (●) with a picture inside alerts you to something you MUST do. This example shows that you MUST unplug the power cord.  |





**! WARNING**



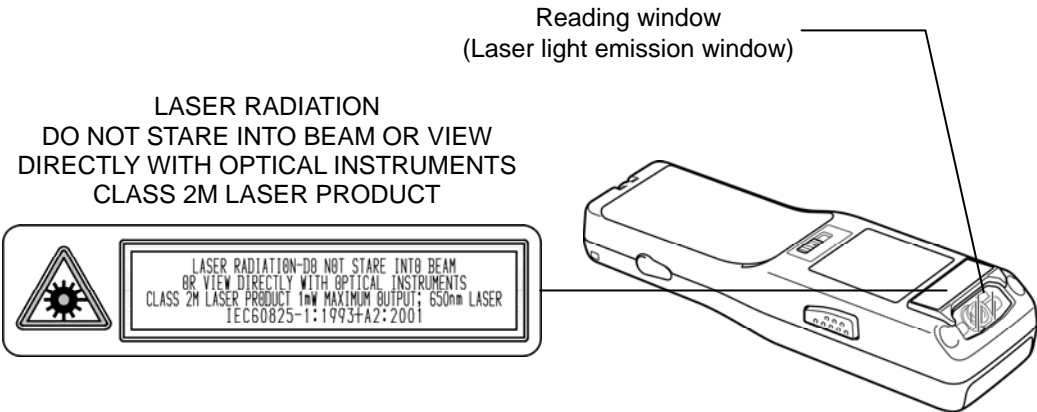

**Handling the battery cartridge**

|   |  |
|---|--|
|  | <ul style="list-style-type: none"> <li>• Never disassemble or heat the battery cartridge, nor put it into fire or water; doing so could cause battery-rupture or leakage of battery fluid, resulting in a fire or bodily injury.</li> <li>• Do not carry or store the battery cartridge together with metallic ball-point pens, necklaces, coins, hairpins, etc.<br/>Doing so could short-circuit the terminal pins, causing the batteries to rupture or the battery fluid to leak, resulting in a fire or bodily injury.</li> <li>• Never put the battery cartridge into a microwave oven or high-pressure container.<br/>Doing so could cause the batteries to break, generate heat, rupture or burn.</li> <li>• Avoid dropping the battery cartridge or letting it undergo any shock or impact.<br/>Doing so could cause the batteries to break, generate heat, rupture or burn.</li> <li>• Never charge the rechargeable battery cartridge where any inflammable gases may be emitted; doing so could cause fire.</li> </ul> |
|  | <ul style="list-style-type: none"> <li>• Only use the dedicated charger for charging the rechargeable battery cartridge.<br/>Using a different type of charger could cause battery-rupture or leakage of battery fluid and result in a fire, bodily injury, or serious damage to property.</li> </ul>  |

**Handling the BHT**

|   |  |
|---|--|
|  | <ul style="list-style-type: none"> <li>• The BHT uses a laser light for indicating the scanning range. The intensity of the laser light might be too low to inflict bodily injury. However, do not stare into the laser light.<br/>The BHT complies with IEC 60825-1:1993+A2:2001.<br/>In accordance with Clause 5, IEC 60825-1, the following information is provided to the user:</li> </ul> <div style="text-align: center;">  </div> <p><b>Caution</b> - Use of controls or adjustments or performance of procedures other than those specified herein may result in hazardous laser light exposure.</p> |
|  | <ul style="list-style-type: none"> <li>• Never put the BHT into a microwave oven or high-pressure container.<br/>Doing so could cause the BHT to break, generate heat, rupture or burn.</li> </ul>   |

**! WARNING****Handling the CU**

|  |  |
|--|--|
| <br> | <ul style="list-style-type: none"> <li>• If smoke, abnormal odors or noises come from the CU, immediately unplug the AC adapter from the wall socket or CU and contact your nearest dealer.<br/>Failure to do so could cause fire or electrical shock.</li> <li>• If foreign material or water gets into the CU, immediately unplug the AC adapter from the wall socket or CU and contact your nearest dealer.<br/>Failure to do so could cause fire or electrical shock.</li> <li>• If you drop the CU so as to damage its housing, immediately unplug the AC adapter from the wall socket or CU and contact your nearest dealer.<br/>Failure to do so could cause fire or electrical shock.</li> </ul> |
|   | <ul style="list-style-type: none"> <li>• Never use the CU for charging anything other than the specified battery cartridges.<br/>Doing so could cause heat, battery-rupture, or fire.</li> <li>• Never bring any metals into contact with the output terminals.<br/>Doing so could produce a large current through the CU, resulting in heat or fire, as well as damage to the CU.</li> <li>• Never use the CU on the line voltage other than the specified level.<br/>Doing so could cause the CU to break or burn.</li> </ul>  |
|   | <ul style="list-style-type: none"> <li>• Use the dedicated AC adapter only.<br/>Failure to do so could result in fire.</li> <li>• If the power cord of the AC adapter is damaged (e.g., exposed or broken lead wires), stop using it and contact your nearest dealer.<br/>Failure to do so could result in a fire or electrical shock.</li> </ul>  |

 **CAUTION**
**To System Designers:**

- When introducing BHTs in those systems that could affect human lives (e.g., medicines management system), develop applications carefully through redundancy and safety design which avoids the feasibility of affecting human lives even if a data error occurs.

**Handling the battery cartridge**

- Never charge a wet or damp rechargeable battery cartridge. Doing so could cause the batteries to break, generate heat, rupture or burn.

**Handling the BHT**

- If smoke, abnormal odors or noises come from the BHT, immediately turn off the power, pull out the battery cartridge, and contact your nearest dealer. Failure to do so could cause smoke or fire.
- If foreign material or water gets into the BHT, immediately turn off the power, pull out the battery cartridge, and contact your nearest dealer. Failure to do so could cause smoke or fire.
- If you drop the BHT so as to damage its housing, immediately turn off the power, pull out the battery cartridge, and contact your nearest dealer. Failure to do so could cause smoke or fire.
- Do not use batteries or power sources other than the specified ones; doing so could generate heat or cause malfunction.
- When using the hand strap or neck strap, exercise due care to avoid getting them caught in other objects or entangled in rotating machinery. Failure to do so could result in accident or injury.



Never disassemble

- Never disassemble or modify the BHT; doing so could result in an accident such as break or fire.





- Never put the BHT in places where there are excessively high temperatures, such as inside closed-up automobiles, or in places exposed to direct sunlight. Doing so could affect the housing or parts, resulting in a fire.
- Avoid using the BHT in extremely humid or dusty areas, or where there are drastic temperature changes. Moisture or dust will get into the BHT, resulting in malfunction, fire or electrical shock.
- In environments where static electricity can build into significant charges (e.g., if you wipe off the plastic plate with a dry cloth), do not operate the BHT. Doing so will result in malfunction or machine failure.
- When connecting or disconnecting the direct-connect interface cable to/from the BHT, do not plug or unplug it at an angle and do not pull the cable strongly. Doing so will result in a machine failure.
- Do not apply excessive force or pull the battery removal strap strongly when inserting or removing the rechargeable battery cartridge. Doing so will result in damage.



- If the BHT has been stored in a hot (50°C to 60°C, 122°F to 140°F) and humid place, allow it to sit at room temperature and humidity for at least one day before use. Using the BHT with its inside being hot will fail to scan or result in a machine failure.

 **CAUTION**

**Handling the CU**

|   |   |
|---|---|
|    | <ul style="list-style-type: none"> <li>• Never disassemble or modify the CU; doing so could result in an accident such as fire or malfunction.</li> </ul>   |
|    | <ul style="list-style-type: none"> <li>• Never put the CU in places where there are excessively high temperatures, such as inside closed-up automobiles, or in places exposed to direct sunlight.<br/>Doing so could affect the housing or parts, resulting in a fire.</li> <li>• Avoid using the CU in extremely humid or dusty areas, or where there are drastic temperature changes.<br/>Moisture or dust will get into the CU, resulting in malfunction, fire or electrical shock.</li> <li>• Never cover or wrap up the CU or AC adapter in a cloth or blanket.<br/>Doing so could cause the unit to heat up inside, deforming its housing, resulting in a fire.<br/>Always use the CU and AC adapter in a well-ventilated area.</li> <li>• Do not place the CU anywhere where it may be subjected to oily smoke or steam, e.g., near a cooking range or humidifier.<br/>Doing so could result in a fire or electrical shock.</li> <li>• Keep the power cord away from any heating equipment.<br/>Failure to do so could melt the sheathing, resulting in a fire or electrical shock.</li> <li>• Do not insert or drop foreign materials such as metals or anything inflammable through the openings or vents into the CU.<br/>Doing so could result in a fire or electrical shock.</li> </ul> |
|  | <ul style="list-style-type: none"> <li>• If you are not using the CU for a long time, be sure to unplug the AC adapter from the wall socket for safety.<br/>Failure to do so could result in a fire.</li> <li>• When caring for the CU, unplug the AC adapter from the wall socket for safety.<br/>Failure to do so could result in an electrical shock.</li> </ul>   |

## Declaration of Conformity (For European Union)

English: Hereby, DENSO WAVE INCORPORATED, declares that this BHT-500BW contains Wireless LAN Module type: **WM-G-MR-01**) that is in compliance with the essential requirements and other relevant provisions of Directive 1999/5/EC.

Česky: Firma DENSO WAVE INCORPORATED tímto prohlašuje, že její radio- a telekomunikační terminál BHT-500BW obsahuje bezdrátový síťový (LAN) modul (typ **WM-G-MR-01**), který se shoduje se základními požadavky a dalšími příslušnými ustanoveními směrnice 1999/5/ES.

Dansk: Undertegnede, DENSO WAVE INCORPORATED, erklærer herved, at følgende udstyr, BHT-500BW, indeholder en trådløs netværkskomponent (type: **WM-G-MR-01**), som overholder de væsentlige krav og øvrige relevante krav i Rådets direktiv 1999/5/EF.

Deutsch: Hiermit erklärt der Hersteller, DENSO WAVE INCORPORATED, dass sich das Gerät: BHT-500BW (mit Wireless LAN Modul „Typ: **WM-G-MR-01**“), in Übereinstimmung mit den grundlegenden Anforderungen und den übrigen einschlägigen Bestimmungen der Richtlinie 1999/5/EG befindet.

Eesti: Käesolevaga kinnitab DENSO WAVE INCORPORATED, et seade BHT-500BW sisaldab traadita kohtvõrgu moodulit (tüüp: **WM-G-MR-01**), mis vastab direktiivi 1999/5/EÜ põhinõuetele ja nimetatud direktiivist tulenevatele muudele asjakohastele sätetele.

Español: Por medio de la presente, DENSO WAVE INCORPORATED, declara que el BHT-500BW incluye módulo de red inalámbrica ( tipo: **WM-G-MR-01**), el cual cumple con los requisitos esenciales y otras disposiciones aplicables o exigibles de la Directiva 1999/5/CE.

Ελληνική: Με το παρόν η DENSO WAVE INCORPORATED, δηλώνει ότι αυτή η συσκευή BHT-500BW περιλαμβάνει μονάδα ασύρματου τοπικού δικτύου Wireless LAN (τύπος: **WM-G-MR-01**), η οποία πληροί τις βασικές απαιτήσεις και τις λοιπές σχετικές διατάξεις της Οδηγίας 1999/5/EK.

Français: Par la présente DENSO WAVE INCORPORATED déclare que le terminal BHT-500BW est doté d'un module de connexion à un réseau local sans fil (type: **WM-G-MR-01**) conforme aux exigences essentielles et aux autres dispositions pertinentes de la directive 1999/5/CE.

Italiano: Con la presente, DENSO WAVE INCORPORATED, dichiara che questo BHT-500BW contiene il modulo wireless LAN (modello: **WM-G-MR-01**), che è conforme ai requisiti essenziali ed alle altre disposizioni pertinenti stabilite dalla direttiva 1999/5/CE.

Latviski: Ar šo DENSO WAVE INCORPORATED deklarē, ka BHT-500BW satur bezvadu LAN moduli (tips: **WM-G-MR-01**), kas atbilst Direktīvas 1999/5/EK būtiskajām prasībām un citiem ar to saistītajiem noteikumiem.

Lietuvių: Šiuo „DENSO WAVE INCORPORATED“deklaruoja, kad šis BHT-500BW įrenginys su bevielio LAN moduliu (tipas **WM-G-MR-01**) atitinka esminius reikalavimus ir kitas 1999/5/EB Direktyvos nuostatas.

Nederlands: Hierbij verklaart DENSO WAVE INCORPORATED dat het toestel BHT-500BW een draadloze LAN Module (type: **WM-G-MR-01**) bevat, die in overeenstemming is met de essentiële eisen en de andere relevante bepalingen van richtlijn 1999/5/EG.

Malti: Hawn hekk, DENSO WAVE INCORPORATED tiddikjara li dan il- BHT-500BW fih Wireless LAN Module (tip: **WM-G-MR-01**), li hu konformi mal-kondizzjonijiet essenzjali u provvedimenti rilevanti oħra tad-Direttiva 1999/5/KE.

Magyar: Alulírott, DENSO WAVE INCORPORATED, nyilatkozom, hogy a BHT-500BW típusú készülék vezeték nélküli helyi hálózati (Wireless LAN) modult (**WM-G-MR-01** típus) tartalmaz, amely megfelel a vonatkozó alapvető követelményeknek és az 1999/5/EK irányelv egyéb előírásainak.

Polski: Niniejszym, DENSO WAVE INCORPORATED, oświadcza, że ten BHT-500BW zawiera moduł łączności bezprzewodowej dla sieci LAN (typu: **WM-G-MR-01**) i jest zgodny z zasadniczymi wymogami oraz pozostałymi stosownymi postanowieniami Dyrektywy 1999/5/EC.

Português: DENSO WAVE INCORPORATED declara que este BHT-500BW inclui um Módulo LAN sem fios (tipo: **WM-G-MR-01**), o qual está conforme aos requisitos essenciais e a outras disposições da Directiva 1999/5/CE.

Slovensko: Podjetje DENSO WAVE INCORPORATED izjavlja, da ta BHT-500BW vsebuje brezžični modul LAN (tip: **WM-G-MR-01**), ki je v skladu z bistvenimi zahtevami in drugimi pripadajočimi določili direktive 1999/5/ES.

Slovensky: Firma DENSO WAVE INCORPORATED týmto vyhlasuje, že jej rádio- a telekomunikačný terminál BHT-500BW obsahuje bezdrôtový sieťový (LAN) modul (typ **WM-G-MR-01**), ktorý spĺňa základné požiadavky a všetky príslušné ustanovenia Smernice 1999/5/ES.

Suomi: Täten DENSO WAVE INCORPORATED vakuuttaa, että tämän tuotteen BHT-500BW sisältämä langaton WLAN-moduli (tyyppi **WM-G-MR-01**) on direktiivin 1999/5/EY oleellisten vaatimusten ja sen tätä tuotetta koskevien muiden ehtojen mukainen.

Svenska: Härmed intygar DENSO WAVE INCORPORATED att denna BHT-500BW innehåller en trådlös LAN-modul (type: **WM-G-MR-01**), som står i överensstämmelse med de väsentliga egenskapskrav och övriga relevanta bestämmelser som framgår av direktiv 1999/5/EG

Íslenska: Hér með lýsir DENSO WAVE hf. því yfir að þetta BHT-500BW inniheldur þráðlausa staðarnetseiningu (tegund: **WM-G-MR-01**), sem er í samræmi við grundvallarkröfur og önnur viðeigandi ákvæði reglugerðar 1999/5/EB.

Norsk: DENSO WAVE INCORPORATED erklærer med dette at denne BHT-500BW inneholder trådløst LAN-nettverksmodul (type: **WM-G-MR-01**), som er i samsvar med regelverk og øvrige bestemmelser i direktiv 1999/5/EC.

## CE marking:



LABELING:

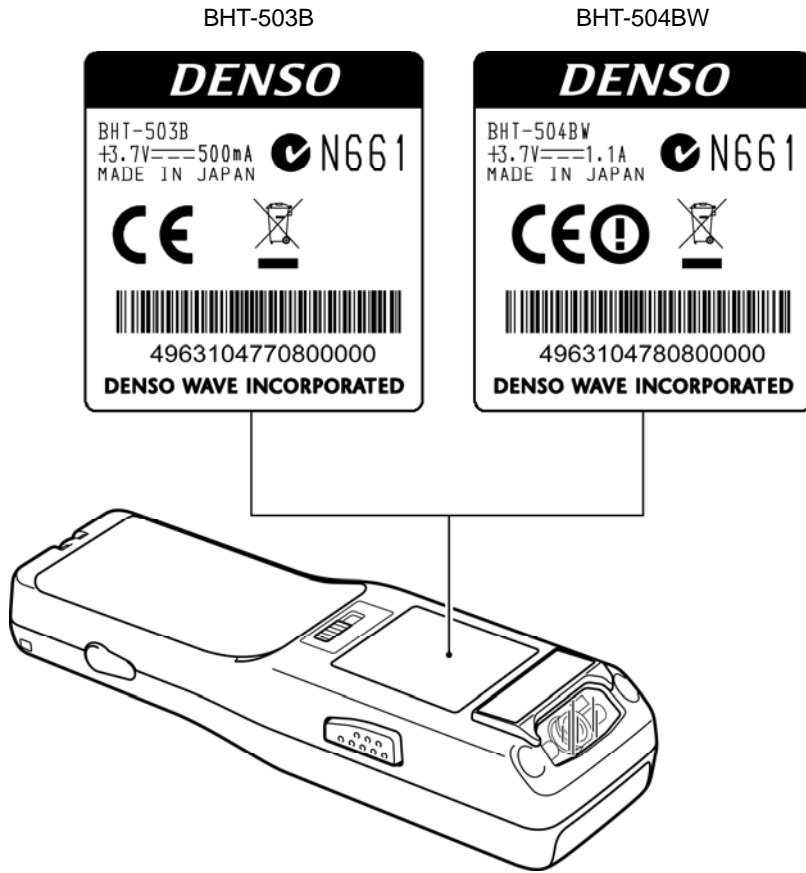





**BHT-500B**

# Chapter 1

# Outline

This chapter describes the BHT system and provides an overall outline of the BHT.

|       |                                     |    |
|-------|-------------------------------------|----|
| 1.1   | System Configuration .....          | 2  |
| 1.1.1 | Hardware Configuration .....        | 2  |
| 1.1.2 | Software Configuration .....        | 5  |
| 1.2   | Component Names and Functions ..... | 8  |
| 1.2.1 | BHT Front/Rear .....                | 8  |
| 1.2.2 | Keypad .....                        | 9  |
| 1.2.3 | BHT Screen .....                    | 11 |

# 1.1 System Configuration

This section describes the hardware required for the barcode data collection system used by the BHT and the BHT software.

## 1.1.1 Hardware Configuration

In addition to the BHT, the following hardware and software are required for the barcode data collection system used by the BHT.

Please note that certain components of the required hardware will differ depending on the type of communication used.

- Host computer
- CU-500 Series (option): Optical communication unit
- Connection cable (option): Used to connect the BHT and host computer.
- Wireless LAN access point (option) \*
- Software: BHT-BASIC 4.0 Development Pack (Option) and BHT-BASIC 4.0 Transfer Utility (Option)

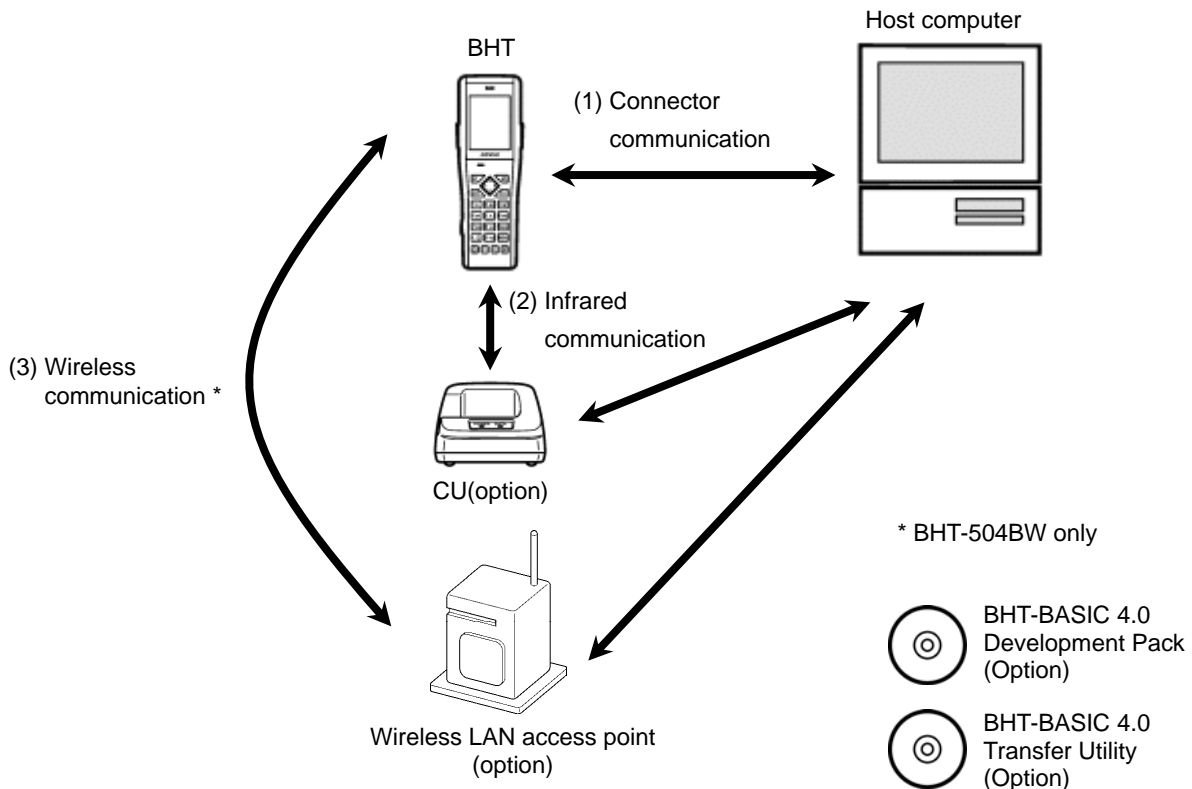

• : Required for system configuration

|                              | Host computer | BHT | CU | Wireless LAN access point | Software | Ref. Page |
|------------------------------|---------------|-----|----|---------------------------|----------|-----------|
| (1)Connector communication   | •             | •   | —  | —                         | •        | Page 34   |
| (2) Infrared communication   | •             | •   | •  | —                         | •        | Page 35   |
| (3) Wireless communication * | •             | •   | —  | •                         | •        | Page 36   |

### ◆ Host Computer

Allows you to edit, manage and download user programs and data, as well as downloading system programs.

Models : PC/AT Compatible

#### Operating Systems and Optional Application Programs

| Operating Systems (OS)         | Windows 98 | Windows NT<br>3.51/4.0 | Windows 2000<br>Professional | Windows XP |
|--------------------------------|------------|------------------------|------------------------------|------------|
| BHT-BASIC4.0 Development Pack  | –          | –                      | √                            | √          |
| BHT-BASIC4.0 Transfer Utility* | √          | √                      | √                            | √          |

\*This application does not activate any built-in IrDA interface port.

### ◆ CU-500 Series (Option)

Used for communication between the BHT and host computer.

Communication with the BHT is performed by infrared communication, and communication with the host computer is performed with an RS-232C, Ethernet or USB interface.

The following three types of CU are available depending on the interface used to communicate with the host computer.

- CU-501: RS-232C interface
- CU-511: Ethernet
- CU-521: USB interface

### ◆ Connection Cable (Option or Commercially Available Product)

Used to connect the host computer and CU-500 Series.

Select a cable suited to the CU-500 Series interface being used.

#### Supported CU-500 Series Cables

- CU-501: RS-232C cable (Option)
- CU-511: Ethernet (10BASE-T) cable (commercially available product)
- CU-521: USB cable (Option)

Furthermore, by preparing the BHT connector interface and cable suited to each connection port, connection is also possible between the BHT and host computer, between the BHT and modem, and between BHT units.

Please note, however, that the BHT connector interfaces have not been designed for frequent cable insertion and removal and therefore use of the CU-500 Series is recommended.

\* Refer to "Chapter 8 Specifications" for further details on BHT interfaces.

### ◆ Wireless LAN Access Point (Option) (\*BHT-504BW only)

Used for wireless communication between the BHT-504BW and host computer.

The BHT-504BW is compatible with wireless LAN standard IEEE802.11g/b and can therefore be used with existing wireless LAN infrastructure. (Max. wireless communication speed: 54Mbps)

Furthermore, the BHT-504BW is WPA compatible to ensure maximum security.

◆ **BHT-BASIC 4.0 Development Pack (Option) and BHT-BASIC 4.0 Transfer Utility (Option)**

Refer to “Software Configuration” on the following page.

## 1.1.2 Software Configuration

This section describes the software used for BHT Series application development and application in addition to the software used at the BHT unit.

Please note that the above-mentioned software can be downloaded (Certain versions may be for trial use.) from the QBdirect service discussed at “Customer Registration” on page ii.

### [1] Application Development Procedure

The procedure for BHT Series program development is as follows.

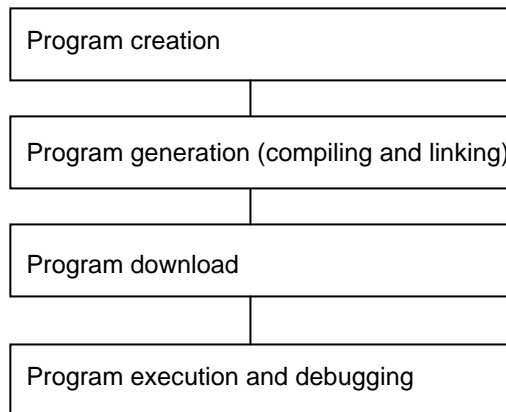

### [2] Software Used for Application

#### ◆ BHT-BASIC Programmer’s Manual for BHT-500 Series

This is an instruction manual used to create handy terminal programs with BHT-BASIC.

#### ◆ BHT-BASIC 4.0 Development Pack (option)

This is a package containing four software products required for BHT Series application development and accessories.

The BHT-BASIC 4.0 Development Pack contains the following products.

- BHT-BASIC 4.0 Compiler  
Compiles and links a source program written in BHT-BASIC 4.0 to create a user program executable on the BHT (\*.PD4).
- BHT-BASIC 4.0 Simulator  
Performs an operation check for generated application programs (\*.PD4) at the computer.
- BHT-BASIC 4.0 Remote Debugger  
Uses the BHT unit to debug generated application programs (\*.PD4) at the computer.

- **BHT-BASIC4.0 Transfer Utility**  
Transfers files between the host computer and BHT at the host computer. YMODEM or BHT-Ir protocol is used for file transfer. BHT-BASIC 4.0 specification files such as application programs and data files are transferred using YMODEM protocol.
- **BHT-PC Cable (RS-232C)**  
This cable can be used to connect the BHT and computer using the BHT connector interface and computer RS-232C interface.  
(Note) The BHT connector interface has not been designed for frequent removal and insertion of the cable. The CU-500 Series should normally be used. Refer to “Chapter 5 Communication” - “5.1 Connector Communication (RS-232C Interface)” for details on the connector interface.

◆ **BHT-BASIC4.0 Transfer Utility (Option)**

This is the same BHT-BASIC 4.0 Transfer Utility that comes bundled with the BHT-BASIC 4.0 Development Pack.

**[3] Software Used at the BHT Unit**

The BHT unit FLASH memory has a system area and user area, with the system program stored in the system area and font files and user programs stored in the user area.

The BHT unit is shipped with the system program and font files stored in their respective areas.

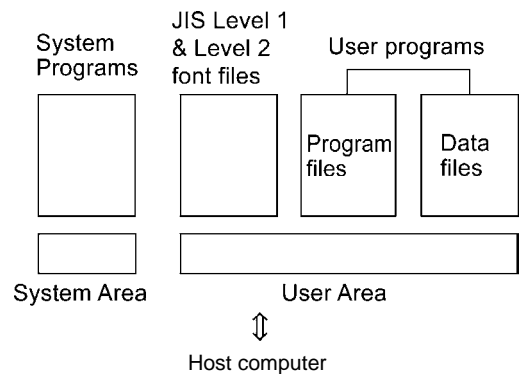

Application programs (\*.PD4) stored in the user area are run by the system program in order to use the BHT.

It is necessary to download application programs (\*.PD4) and data files (product master files etc.) required to run application programs (\*.PD4) to the BHT user area prior to use.

◆ **System Program**

- **Driver**  
Drivers is a set of programs that directly controls the BHT hardware. It can be called up by the BHT-BASIC Interpreter or System Mode.
- **BHT-BASIC Interpreter**  
This program interprets application program (\*.PD4) command language and controls the BHT unit hardware via drivers.

- System Mode

This program is used to operate files, make system environment settings, and perform various types of tests.

Refer to "Chapter 4 System Operation" –"4.4 System Mode" for further details.

## ◆ Font File

These files are required to display JIS 1 and 2 standard Kanji characters at the BHT unit LCD display. By using font files, the BHT unit is able to display 16 to 40 dot Kanji in application programs (\*.PD4).

---

– Point – If you do not need to display Kanji characters, you may delete these JIS font files. After deletion, the memory area which was occupied by these files can be used as a user area. For the deleting procedure, refer to "Chapter 4 System Operation" - "4.1.4 Performing System Initialization" or "4.5.11 Deleting Font Files (DELETE FILE Menu)."

The names of the font file: FNTFSHG.FN4 (JIS Level 1 and 2 font, 16-dot to 40-dot)

---

## ◆ User Programs

Application programs and data files are downloaded to the BHT user area and are collectively known as user programs.

To download a BHT-BASIC 4.0 specification user program to the BHT unit, the BHT-BASIC 4.0 Transfer Utility is required.

# 1.2 Component Names and Functions

## 1.2.1 BHT Front/Rear

\* BHT-504BW only

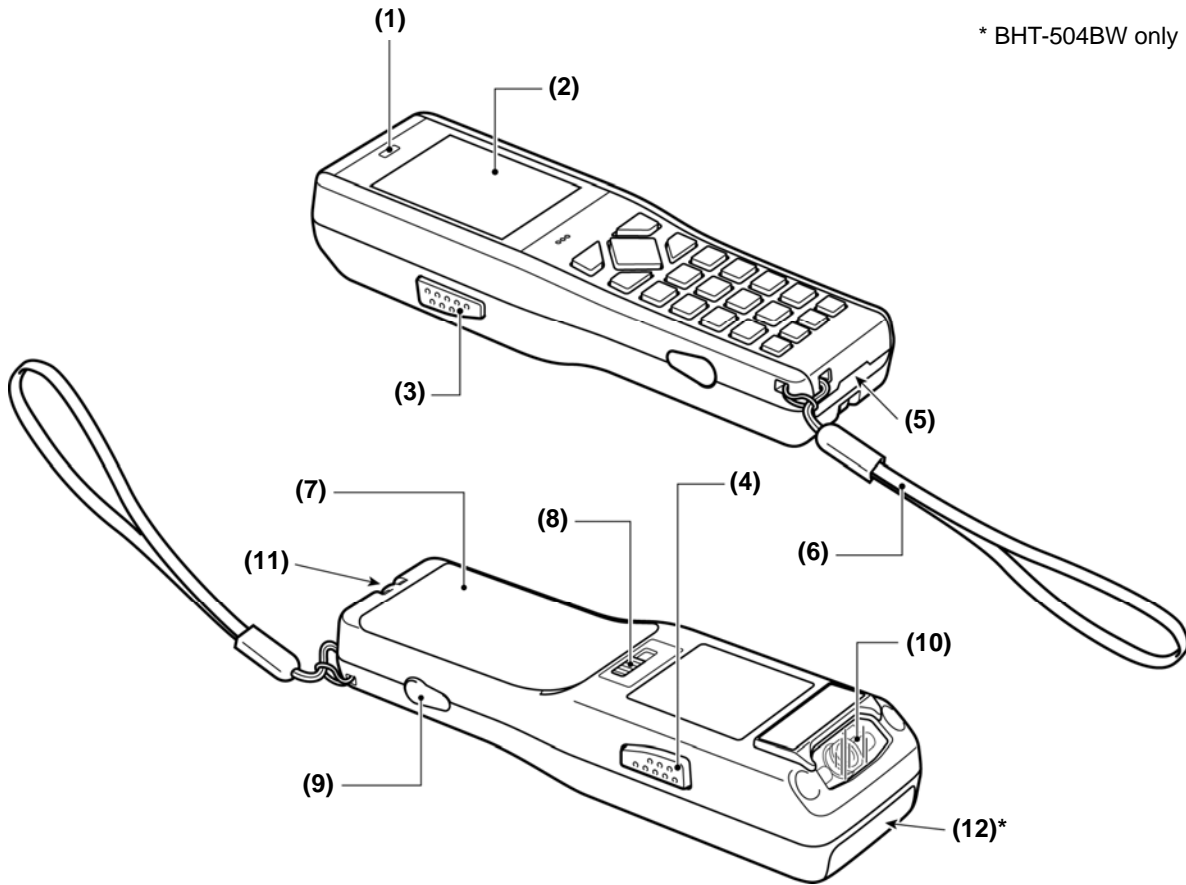

| No.    | Name                            | Function and Description   |
|--------|---------------------------------|--|
| (1)    | Indicator LED                   | Indicates the barcode read status.<br>Illuminates in blue when the BHT has successfully read a barcode.  |
| (2)    | LCD (Liquid crystal display)    | Displays the characters and graphic patterns.  |
| (3)    | Trigger switch                  | Press when scanning a barcode.   |
| (4)    |                                 | The <b>SF</b> and <b>ENT</b> key functions can be assigned to these magic keys by making settings at the SYSTEM MENU.<br>Character strings can be assigned at user programs.<br>* Refer to "Chapter 4 System Operation" for details on how to operate the SYSTEM MENU. |
| (5)    | IrDA interface port             | Used to exchange data/programs with the optical communication unit CU-500 or other BHTs.   |
| (6)    | Hand strap                      | Be sure to put your hand through this strap to prevent you from dropping the BHT accidentally.   |
| (7)    | Battery cover                   | Remove this cover to replace the battery cartridge.  |
| (8)    | Battery cover lock              | Use this to lock or unlock the battery cover.  |
| (9)    | Connector port                  | Inside this cover is the connect interface port.   |
| (10)   | Barcode reading window          | Align the reading window with barcodes to perform barcode scanning.  |
| (11)   | Charge terminal                 | Place on the CU to charge the BHT.   |
| (12) * | IEEE802.11 b/g built-in antenna | Used to communicate with the wireless LAN access point.<br>Do not cover this antenna section with metal-evaporated tape or by hand. Doing so may result in communication failures.   |









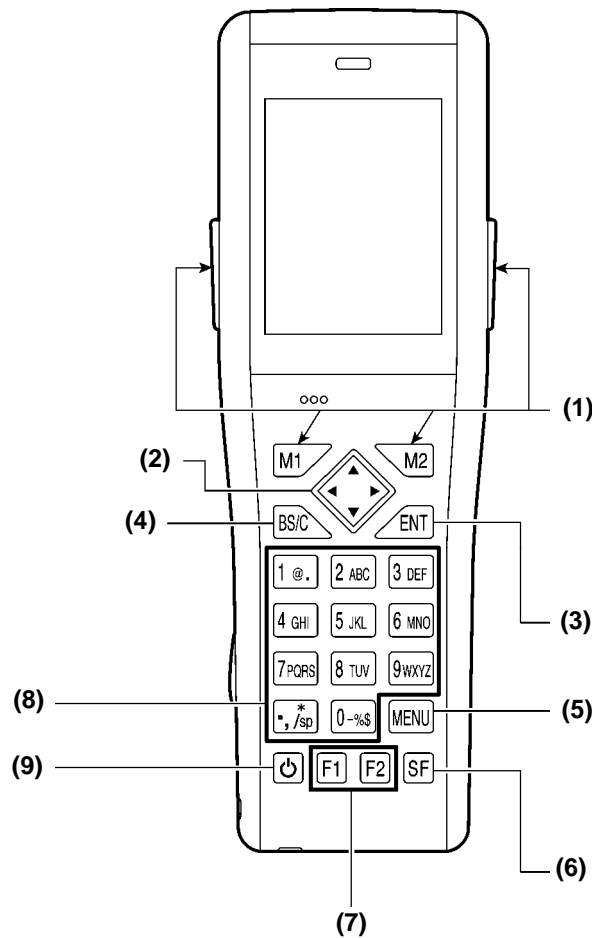

## 1.2.2 Keypad

The BHT key functions can be set at user programs.

The diagram below shows an example of settings for each key function.



| No. | Key   | Name                  | Function and Description  |
|-----|---|-----------------------|---|
| (1) |  | M1,M2,M3,M4 magic key | <ul style="list-style-type: none"> <li>Each of the <b>M3</b> and <b>M4</b> keys is assigned a trigger switch by default.</li> <li>The <b>SF</b>, <b>ENT</b>, <b>Backlight</b> or <b>MENU</b> key functions can be assigned to these magic keys by making settings at the SYSTEM MENU.</li> <li>Character strings can be assigned at user programs.</li> </ul> <p>* Refer to "Chapter 4 System Operation" for details on how to operate the SYSTEM MENU.</p> |
| (2) |  | Cursor keys           | Used to move the cursor and select menus.   |
| (3) |  | Enter key             | Press to finalize entered data or execute operations.   |
| (4) |  | Backspace /Clear key  | Moves back one character.<br>Press this key and the <b>SF</b> key simultaneously or hold down for 0.5 seconds or longer to cancel entry or return to the previous screen.   |

| No. | Key   | Name                       | Function and Description  |
|-----|---|----------------------------|---|
| (5) |    | MENU key<br>(M5 magic key) | Press this key to display the following setting screens when set to the default. <ul style="list-style-type: none"><li>• Beeper volume</li><li>• Vibrator</li><li>• LCD display brightness</li><li>• Power save</li></ul> |
| (6) |    | Shift key                  | Used in combination with other keys such as the numerical keys for special input procedures.  |
| (7) |   | Function keys              | Used to select functions.   |
| (8) |   | Numerical keys             | Used to enter data.   |
| (9) |    | Power key                  | Turns the BHT power ON or OFF.  |

### 1.2.3 BHT Screen

If the system display is set to ON at the system settings or in the user program, icons display at the bottom of the screen (default) indicating the key shift status, alphabet entry status, and status of the link with the CU-511.

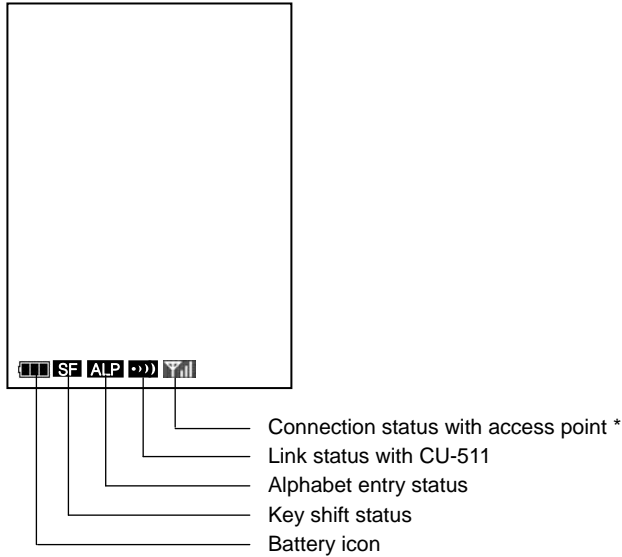

\* BHT-504BW only

|   |  |
|---|--|
|   | This is the battery icon.<br>Indicates the current battery power level.  |
|   | Displays when the <b>SF</b> key is pressed and the keys are in the shift status.   |
|   | When the <b>SF</b> key is pressed while set to alphabet entry mode at the user program, the entry mode changes from "numeric entry" to "alphabet entry" and <b>ALP</b> displays.<br>Alphabet entry is used when performing FTP settings.<br>Refer to the programming manual section 7.2.1 "Numeric, Alphabet Entry" for the input character details while in the ALP mode. |
|   | displays when a link is established with the CU-511.<br>When an attempt is made to perform communication with the CU-511 when no link has been established, the  icon flashes.<br>When there is no response from the CU-511, when waiting for the link with the CU-511 to be established, or when waiting for the link to be disengaged, the icon displays in the order  . |
| * | Displays when the BHT is connected to the access point.<br>The radio field intensity status displays as follows.<br>→  →<br>Strong                      Weak<br>displays when the BHT is not connected to the access point.  |

Outline

BHT Preparation

Basic Operation

System Operation

Communication

Maintenance

Error Messages

Specifications

Appendices

## BHT-500B

### Chapter 2

# BHT Preparation

This chapter describes inserting and charging the battery cartridge, turning the BHT power ON and OFF, and use of the hand strap.

|       |  |    |
|-------|--|----|
| 2.1   | “BHT Preparation” Procedure .....                | 14 |
| 2.2   | Loading and Charging the Battery Cartridge ..... | 14 |
| 2.2.1 | Battery Power Level Indicator .....              | 22 |
| 2.3   | Attaching the Hand Strap .....                   | 23 |
| 2.3.1 | Attaching the Hand Strap .....                   | 23 |
| 2.3.2 | Holding the BHT .....                            | 23 |
| 2.4   | Initial Setup .....                              | 24 |
| 2.5   | Turning OFF the Power .....                      | 25 |
| 2.5.1 | Normal Power OFF .....                           | 25 |
| 2.5.2 | Turning the Power OFF after Data Back-up .....   | 25 |
| 2.5.3 | Auto Power OFF .....                             | 25 |
| 2.5.4 | If the BHT Is Shut Down Abnormally .....         | 26 |
| 2.5.5 | If Invalid Files Are Found .....                 | 28 |

## 2.1 “BHT Preparation” Procedure

Follow the steps below to prepare the BHT for use.

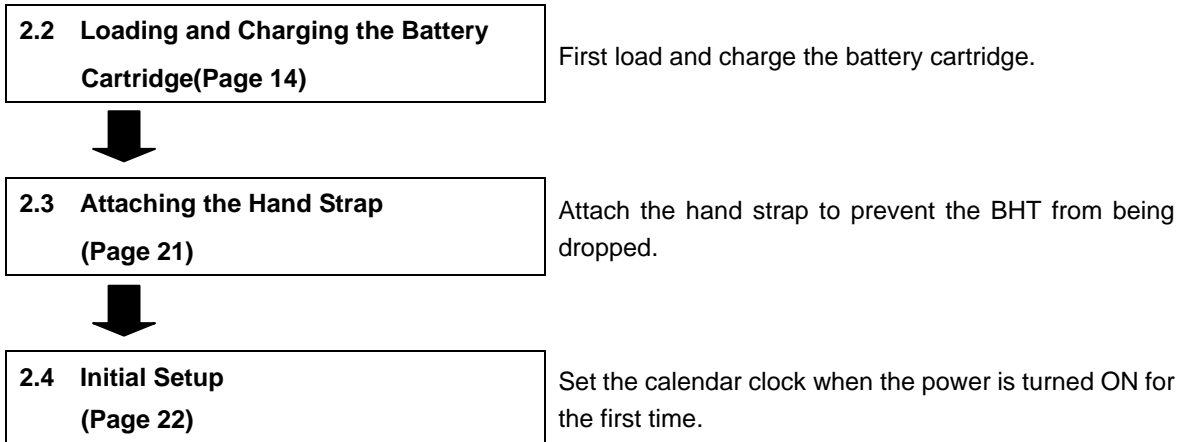

## 2.2 Loading and Charging the Battery Cartridge

The battery cartridge is not charged when purchased and should therefore be charged prior to use. The chargers that can be use with the BHT are the communication units (CU-501, CU-511 and CU-521) and battery chargers (CH-501 and CH-551).

- \* The CH-501 charger is used for charging individual batteries, and the CH-551 is a stand-type (same type as CU (communication unit)) charger.

**The charge time is approximately 3 hours.**

- The charge time is approximately 4 hours using the CU-521 with power supplied via the USB port.
- An only slightly discharged battery cartridge should take less time to become fully charged.

### Charging Precautions

- Do not touch the BHT, battery, or charger terminals by hand or stain them. Doing so could result in a contact failure or prevent charging.
- Never charge the battery near fire or in a high-temperature environment. High-temperatures may activate the charger’s protective device, preventing charging, and lead to protective device damage, overheating, blowout or combustion.
- Terminate charging if not completed even after the specified time has elapsed.

**Charging with the communication unit (CU-501, CU-511 and CU-521)  
or battery charger (CH-551)**



1. Slide the battery cover lock (1) in the direction shown by the arrow, and remove the battery cover (2).

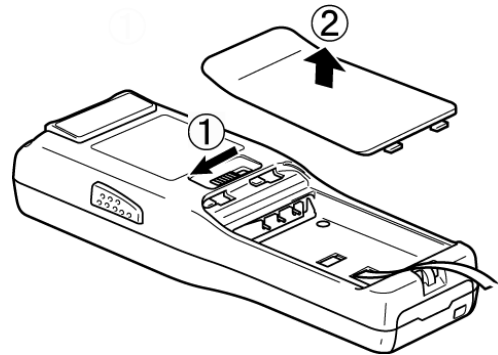

2. Check the battery cartridge terminals and direction indication on the BHT, and insert the battery cartridge in the direction shown by the arrow.

– Point – Pull the battery pull strap upward as shown on the right to remove the battery cartridge easily.

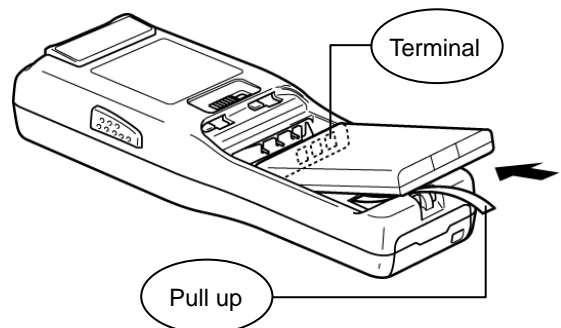

3. Close the battery cartridge cover (1) and return the battery cover lock (2).

– Point – Ensure that the battery pull strap is not jammed by the cover.

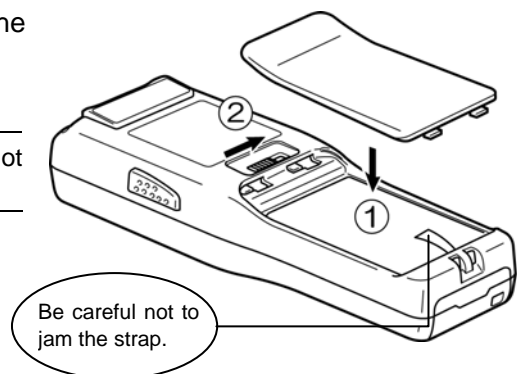

4. Connect the dedicated AC adapter to the DC input connector on the charger and plug the adapter into the wall socket.

The charger Power LED (green) turns ON.

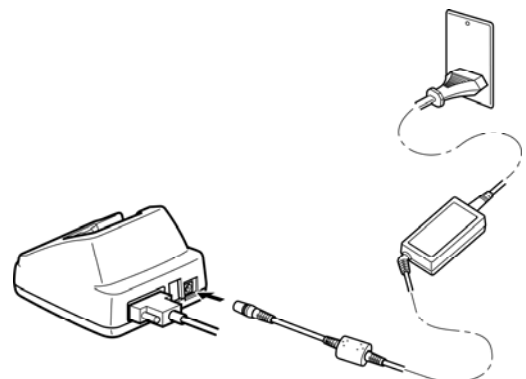

- 
- **Note** – Power for the CU-521 can be obtained from a USB connection port (host computer or hub), however, charging is not possible while the host computer is in suspend mode. Charging is resumed when suspend mode is exited. This can be avoided using a dedicated AC adapter to supply power. Suspend mode is a power saving function used to temporarily put the computer on standby when not in use.
- 

## 5. Place the BHT on the charger.

The LED illuminates in red and charging begins.

- 
- **Point** – After placing the BHT on the charger when using the BHT for the first time or when left unused for long periods of time, do not remove from the charger for approximately 10 minutes.
- 



- 
- **Note** – The BHT is equipped with a back-up battery used to back-up the internal memory and calendar clock. The internal back-up battery is charged first when charging is commenced. Do not remove the BHT from the charger for at least 10 minutes when using the BHT for the first time or when using after long periods of time.
-



6. The BHT indicator LED will change to green when charging is complete.



- 
- Point –
- Charging takes approximately 3 hours.
  - Charging takes approximately 4 hours when using the CU-521 with power supplied via the USB port.
  - An only slightly discharged battery cartridge should take this time to become fully charged.
  - The indicator LED flashing in red indicates the following causes. The proper action stated below must be taken.
    - Abnormal temperature of the battery cartridge is detected.
      - Charge the battery cartridge under the proper temperature (0°C~40°C)
      - Avoid places where there are objects generating heat nearby or exposed to direct sunlight.
      - Terminate charging and replace the battery cartridge if there are no objects generating heat nearby.
    - The charge terminals contact failure
      - Wipe any dirt or dust from the charge terminals as described in “6.3 Daily Maintenance”.
    - Charging is not completed even after the specified time has elapsed.
      - Terminate charging and use a dedicated AC adapter to charge the battery cartridge if the battery cartridge is charging through an unpowered USB.
    - The battery cartridge is broken or the battery life has ended.
      - Replace the battery cartridge.
-

## Charging with the battery charger (CH-501)



1. Check the battery cartridge terminals and insert the cartridge.

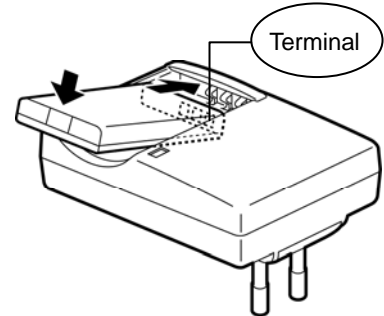

2. Connect the CH-501 plug to a commercial AC power source (230 V AC).

The LED will turn red when charging is commenced.

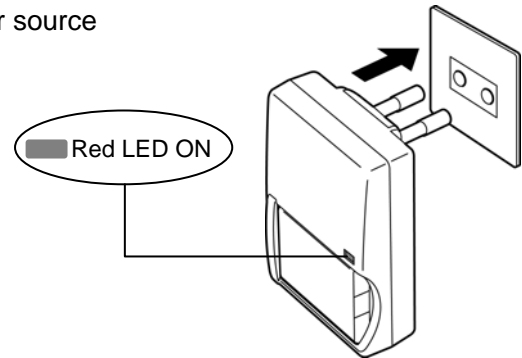

3. The LED will turn green when charging is complete.

- Point –
- Charging takes approximately 3 hours.
  - An only slightly discharged battery cartridge should take this time to become fully charged.

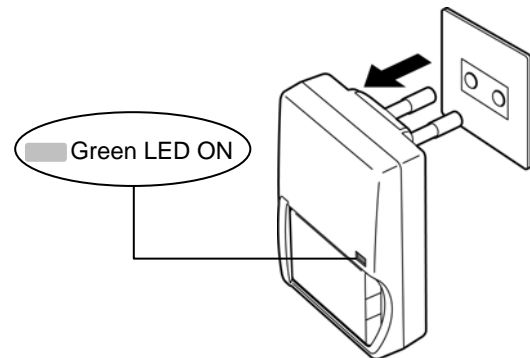

4. Slide the battery cover lock (1) in the direction shown by the arrow, and remove the battery cover (2).

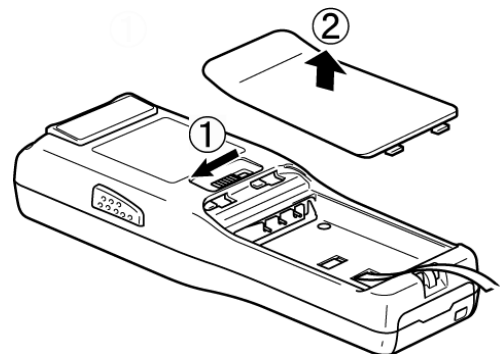

5. Check the battery cartridge terminals and direction indication on the BHT, and insert the battery cartridge in the direction shown by the arrow.

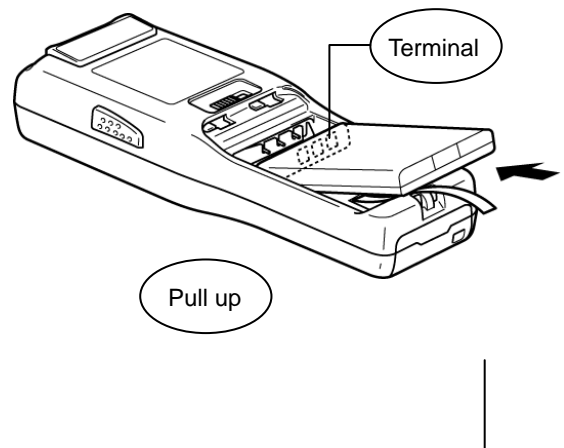

– **Point** – Pull the battery pull strap upward as shown on the right to remove the battery cartridge easily.

6. Close the battery cartridge cover (1) and return the battery cover lock (2).

– **Point** – Ensure that the battery pull strap is not jammed by the cover.

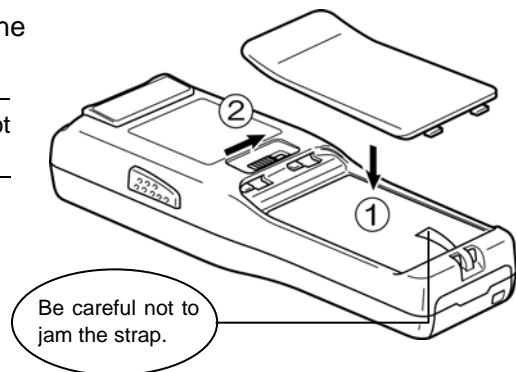

– **Point** – The indicator LED flashing in red indicates the following causes. The proper action stated below must be taken.

- Abnormal temperature of the battery cartridge is detected.
  - Charge the battery cartridge under the proper temperature (0°C~40°C)
  - Avoid places where there are objects generating heat nearby or exposed to direct sunlight.
  - Terminate charging and replace the battery cartridge if there are no objects generating heat nearby.
- The charge terminals contact failure
  - Wipe any dirt or dust from the charge terminals as described in “6.3 Daily Maintenance”.
- The battery cartridge is broken or the battery life has ended.
  - Replace the battery cartridge.

– **Note** – The BHT is equipped with a back-up battery used to back-up the internal memory and calendar clock. The internal back-up battery is charged first when charging is commenced.

Do not remove the BHT from the charger for at least 10 minutes when using the BHT for the first time or when using after long periods of time.



Mishandling of the charger may result in charger overheating, smoke generation, blowout or combustion. Please read the following items prior to use.

**⚠ WARNING**

- Never disassemble or modify the battery cartridge.
- Never connect the battery cartridge (+) and (-) terminals with a metal object such as a piece of wire.
- Never carry or store the battery cartridge together with metallic necklaces, hairpins and so on.
- Never expose the battery cartridge to fire or apply heat.
- Never use or leave the battery cartridge in the vicinity of high-temperature locations (60° C or higher) such as a fire or stove.
- Never place the battery cartridge into or soak it in water or seawater.
- Never charge the battery cartridge in the vicinity of fire or under a scorching sun.
- Never hammer nails into the battery cartridge, hit it with a hammer, or trample on it.
- Never apply strong impact to or throw the battery cartridge.
- Never use significantly damaged or deformed battery cartridges.
- Never apply solder directly to the battery cartridge.
- If battery fluid leaked from the battery cartridge gets into the eyes or comes into contact with the skin, wash thoroughly with clean water such as tap water without rubbing, and obtain medical treatment immediately. Failure to do so will result in eye or skin injuries.

**⚠ CAUTION**

Mishandling of the charger may result in charger overheating, smoke generation, blowout or combustion. Please read the following item prior to use.

- Terminate charging if not completed even after the specified time has elapsed.

– Note –

- The BHT is equipped with a back-up battery used to back-up the internal memory and calendar clock when the battery cartridge is removed or the battery voltage falls below the stipulated level.  
It is therefore necessary to charge the internal back-up battery when using the BHT for the first time or when left unused for long periods of time.  
The back-up battery is charged automatically when a fully-charged battery cartridge is loaded.  
To ensure that the back-up battery is fully charged, do not remove the battery cartridge for at least 10 minutes when using the BHT for the first time or when using after long periods of time.
- If you leave the BHT without a battery cartridge loaded for a long time, the memory contents will no longer be backed up so that the message "Contact your administrator. Note the error number. (XXXX)" or "Set the current date and time." may appear on the LCD.
- Refer to "Chapter 6 Maintenance" – "6.2 Using the BHT after Long Periods" for details of handling the BHT after long periods of time.
- Avoid storing the battery cartridge in high-temperature locations. The battery capacity may decrease.
- Do not touch the BHT, battery, or charger terminals by hand or stain them. Doing so may result in a BHT operation defect or battery cartridge charging failure. It is recommended that dirt on the battery cartridge terminals or BHT battery terminals be periodically wiped with a soft, dry cloth.





## 2.2.1 Battery Power Level Indicator

### Confirming at the Power Level Icon

The battery power level can be confirmed at the battery icon (  ) that displays in the bottom left of the LCD display.

The battery power displays in four levels.

The battery power level indicator is a guideline to notify the operator to charge the battery promptly when discharged.

-  : Sufficient battery power remains.
-  : The battery power is partially depleted. Charge promptly.
-  : The battery power is almost fully depleted. Charge immediately.
-  : The battery power is fully depleted.  
Charge immediately or replace with a fully charged battery cartridge.

### Confirming at the “Battery Voltage” Screen

The battery power level can also be confirmed at the "Battery Voltage" screen.

The "Battery Voltage" screen displays the battery power level in more detail than the battery icon (  ) that displays at the LCD display.

Display the "Battery Voltage" screen using the following procedure.

1. Hold down the **SF** key and press the **Enter** key.

The "Battery Voltage" screen displays while the keys are pressed.

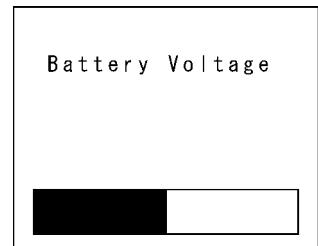

#### About the Battery Level

- The battery power level indicator does not accurately reflect the battery residual power and should only be used as a guideline.
- The battery power level will fluctuate due to BHT operation, and therefore disparities may occur between the actual battery voltage and the display indicator.
- Ensure to charge the battery as soon as possible before the battery power is depleted.

– Point – • If the BHT is placed in the alphanumeric entry system in user programs, the combination of the **SF** and **ENT** keys cannot be used for displaying the battery voltage level. This is because in the alphanumeric entry system the **SF** key is used for switching between the numeric and alphabet entry modes.

– TIP – • In user programs, you may select the key to be used for displaying the battery voltage level (instead of the default: combination of **SF** and **ENT** keys).  
 • The displayed battery level shows the terminal voltage of the battery, not how much power is left.  
 • The actual voltage level varies depending upon the operation of the BHT, so the displayed level also may vary.

## 2.3 Attaching the Hand Strap

Attach the hand strap to prevent the BHT from being accidentally dropped during use.

### 2.3.1 Attaching the Hand Strap

Attach the hand strap as shown below.

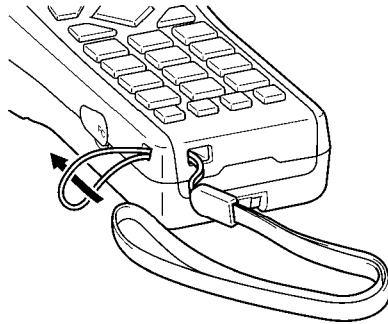

### 2.3.2 Holding the BHT

Attach the hand strap to your wrist and hold the BHT as shown below.

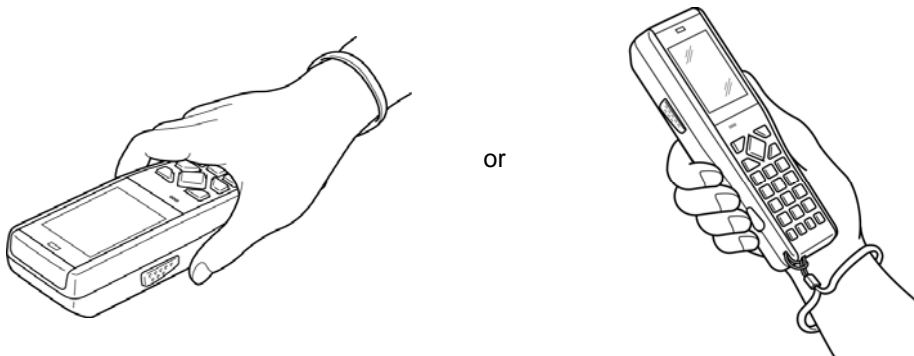

## 2.4 Initial Setup

Turn ON the power after inserting the fully charged battery cartridge into the BHT.

The clock will not have been set at the time of purchase, and therefore it is necessary to set the date and time when turning ON the power for the first time.

1. Press the **Power** key (  ) to turn ON the BHT power.

The screen right displays.

```
Set the current
date and time.
```

```
00/01/01 00:00
_ / /      :
```

2. Enter the date and time using the numeric keys.

[Ex.] : February 14, 2008, 14:20

---

- **Point** - Enter the last two digits for the year, and enter the time in 24-hour clock format.

---

```
Set the current
date and time.
```

```
00/01/01 00:00
08/02/14 14:20
```

3. Press the **ENT** key to set the date and time.

The screen right displays when the date and time are set.

```
No user programs
      found.
Run code scanning
      demo?
```

```
1:Yes  2:No
```

4. Press numeric key **1** followed by **ENT** and select [1:Yes].

A scanning demo commences.

The scanning demo is a program that allows barcodes to be scanned without a user program. Press the trigger switch to enable barcode scanning.

Refer to "Chapter 3 Basic Operation" – "3.1 Scanning Barcodes" and scan a barcode .

---

- **Point** - By selecting [2:No], the power turns OFF.

---



## 2.5 Turning OFF the Power

Use one of the following three methods to turn OFF the BHT power.

Normal power OFF

Turning the power OFF after data back-up

Auto power OFF

→ Press the **Power** key (  ).

→ Hold down the **Power** key (  ) for at least 3 seconds.

→ The power turns OFF automatically when the BHT is not used for a set length of time.

### 2.5.1 Normal Power OFF

#### 1. Press the **Power** key ( ).

The BHT power turns OFF after the screen on the right displays.

– **Point** – Do not remove the battery cartridge while the message on the right is displayed.

When the power is next turned ON, there are times when a message (2XXX) displays asking the user to contact the administrator.

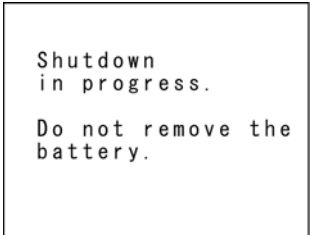

Shutdown  
in progress.  
  
Do not remove the  
battery.

### 2.5.2 Turning the Power OFF after Data Back-up

#### 1. Hold down the **Power** key ( ) for at least 3 seconds.

The message right displays and data back-up is commenced.

The power turns OFF automatically when the back-up is complete.

– **Point** – Do not remove the battery cartridge while the message on the right is displayed.

The back-up process may take several tens of seconds depending on the amount of data.

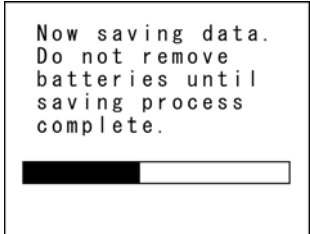

Now saving data.  
Do not remove  
batteries until  
saving process  
complete.

### 2.5.3 Auto Power OFF

The power turns OFF automatically when the BHT is not used for the length of time set at the user program.

The default time is set to 3 minutes when the BHT is shipped from the factory.

\* Refer to “BHT-500 Programmer’s Manual” for details of auto power OFF.

## 2.5.4 If the BHT Is Shut Down Abnormally

If the BHT is shut down abnormally\* and is left without a battery cartridge or with a discharged battery cartridge loaded, then unsaved data may be lost.

(\*"Normally shut down" refers to "2.5 Turning OFF the Power.")

1. The right message will appear when you load a charged battery cartridge and turn the BHT on.

```
Your terminal was
not shut down
properly the last
time it was used.

Unsaved data
was lost.

[Sf+2]
```

2. Press the **2** key while holding down the **SF** key.

The screen will switch to the right.

- [1. Yes]: Run Scandisk and start the System.
- [2. No]: Turn the BHT off.

```
Do you want to
run Scandisk?

1. Yes 2. No
```

3. Choose [1. Yes] with the numerical keys and press the **ENT** key.

When Scandisk is in progress, the right message is displayed.

```
Scandisk is
checking your
drive for errors.
```

If Scandisk finds an invalid file(s), the right screen will appear.  
 (As long as an invalid file exists, the screen displays every time the BHT System is started up.)

(Refer to "About "\$\$BRKLST.SYS" on the following page.)

```
Scandisk found
  invalid files.

Refer to the file
"$BRKLST.SYS" for
more information.
```

#### 4. Press the **ENT** key to start up the BHT System.

##### Scandisk when the resume function is enabled

If Scandisk runs when the resume function is enabled, the screen given right may appear.

The BHT displays the screen for three seconds and then automatically runs the execution program from the beginning.

(The screen may also appear when the calendar clock built in the BHT stops, even without running Scandisk.)

```
No resume info.
has been retained.
Program restarts
  automatically.
```

---

– **Point** – The resume function is used to return the display to the status (screen) when the power was last turned OFF when the power is next turned ON.

Resume function settings are made at the "SET SYSTEM" menu. Refer to "Chapter 4 System Operation" - "4.5.5 System Environment Settings (SET SYSTEM Menu)" for further details.

---

**About “\$\$BRKLST.SYS”**

If Scandisk finds an invalid file(s), it will automatically create the "\$\$BRKLST.SYS" file.

To check the contents of the file, upload the file in System Mode to the host computer. (Refer to “Chapter 4 System Operation” – “4.5.3 Uploading Files (UPLOAD MENU).”)

**Contents of the “\$\$BRKLST.SYS” file**

|         |                    |   |
|---------|--------------------|---|
| Records | (1) File name      |   |
|         | (2) Error factor   | + (Broken since the BHT has not been turned off normally)<br>* (Broken due to any other causes) |
|         | (3) Broken records | e.g. 01000-01200 (Data in records numbered 1000 to 1200 is lost)                                |

[Ex.]

|                             |   |  |
|-----------------------------|---|--|
| SAMPLE1.DAT + 01000-01050   | } | If more than one sequence of records is broken in a same file, they will be written into the subsequent records in the "\$\$BRKLST.SYS." |
| SAMPLE1.DAT + 01200-01250   |   |  |
| SAMPLE1.DAT + 01600-01650   |   |  |
| SAMPLE2.DAT * 00250-00275   |   |  |
| SAMPLE3.DAT * 00100-00150   |   |  |
| ↑            ↑            ↑ |   |  |
| (1)        (2)        (3)   |   |  |

**2.5.5 If Invalid Files Are Found**

Even invalid files can be uploaded, so upload them to the host computer according to your needs.

After uploading,

- Delete those invalid files.  
(Refer to “Chapter 4 System Operation” – “4.5.10 Deleting Program/Data Files (DELETE FILE MENU).”)
- Download valid files having the same names as invalid ones.  
(Refer to “Chapter 4 System Operation” – “4.5.2 Downloading Files (DOWNLOAD MENU).”)



**BHT-500B**

## **Chapter 3**

# **Basic Operation**

This chapter describes basic operations such as barcode scanning, numerical data entry and item selection using the BHT, basic changes to settings, and BHT data transmission.

|       |                                     |    |
|-------|-------------------------------------|----|
| 3.1   | Scanning Barcodes .....             | 30 |
| 3.2   | Numeric Data Entry .....            | 32 |
| 3.3   | Task Selection .....                | 32 |
| 3.4   | Changing the Default Settings ..... | 33 |
| 3.4.1 | Procedure .....                     | 33 |
| 3.5   | Transmitting Data .....             | 35 |
| 3.5.1 | Connector Communication .....       | 36 |
| 3.5.2 | Infrared Communication .....        | 37 |
| 3.5.3 | Wireless Communication .....        | 38 |

# 3.1 Scanning Barcodes

Follow the procedure below to scan barcodes.

1. Turn the BHT power ON.

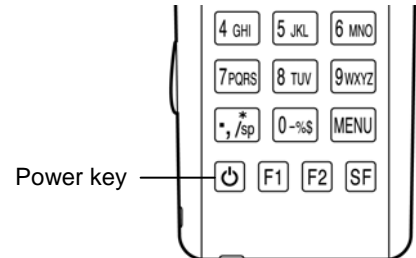

2. Press the trigger switch.

The BHT emits a guide marker (laser light) and illumination LED.

---

- Point - The trigger switch is assigned to magic keys **M3** and **M4** when shipped from the factory.

---

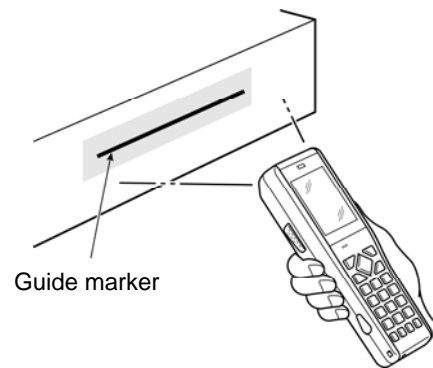

3. Hold the BHT close to the barcode to align the guide marker.

When the BHT has read the barcode successfully, the indicator LED will illuminate in blue.

---

- Point - The barcode scanning method may differ depending on the application. Perform scanning in accordance with the instructions provided in the application User's Manual.

---

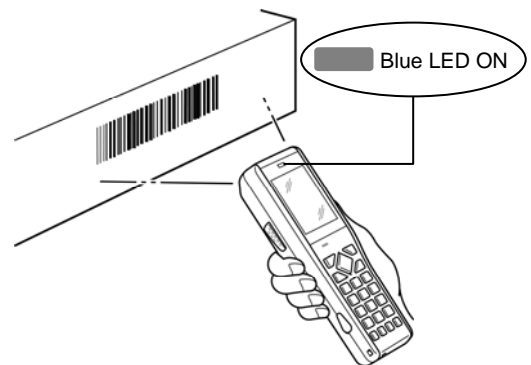

- 
- Note -
- If required, clean dirty labels before scanning.
  - It may not be possible to perform scanning in direct sunlight.
  - If the barcode is on a curved surface, perform scanning in the center of the illumination LED emission range.
  - If the barcode reading window is pulled away from the barcode, the scannable barcode range will become narrower than that of the illumination LED emission.
  - The guide marker display range is only a guideline. The guide marker moves to the right of the scannable range as the barcode reading window nears the barcode, and therefore scanning should be performed so that the barcode comes to the left side of the guide marker.
  - The light intensity of the illumination LED will vary depending upon the scanning conditions and variation of its elements.
-

When unable to successfully read barcodes...

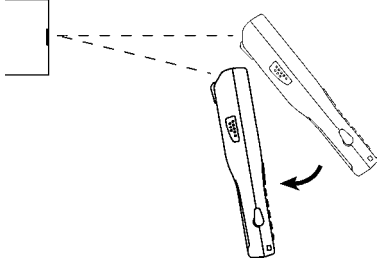
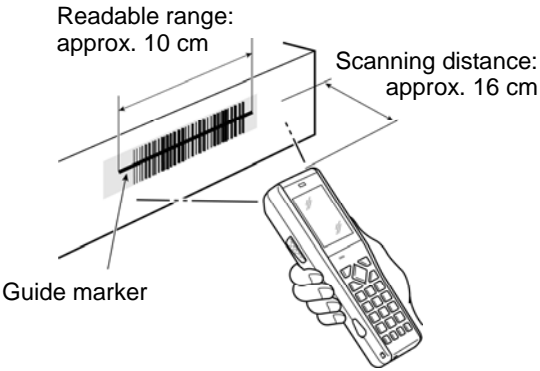



|                                | Cause   | Countermeasure   |
|--------------------------------|---|--|
| Specular reflection            | When the illumination LED is focused on the printed surface of the barcode from directly above, there are times when scanning is unsuccessful due to specular reflection. | <p>Change the BHT scanning angle and try again.</p>    |
| Distance from barcode          | Scanning may be unsuccessful if the BHT reading window is too close to or too far from the barcode, even when the barcode is within the guide marker (laser light) range. | <p>Move the BHT slowly toward or away from the barcode and try again.</p> <p>The guide marker range is only a guideline.</p> <p>The displacement in the right direction in the diagram increases as the BHT nears the barcode, and therefore scanning should be performed so that the barcode comes to the left side of the guide marker.</p> <p>The barcode readable range is approximately 10 cm when the scanning distance is 16 cm.</p>  |
| Barcode surface curvature      | Scanning may be unsuccessful if the barcode surface is curved.  | Scan the barcode at the center of the barcode reading window.  |
| Barcode surface dirt           | Scanning may be unsuccessful if the barcode surface is dirty.   | Wipe the dirt from the barcode and try again.  |
| Barcode reading window dirt    | Scanning may be unsuccessful if the barcode reading window is dirty.  | Blow any dust away with an airbrush, and then gently wipe the reading window with a cotton swab or similar soft object.  |
| Direct sunlight, ambient light | Barcode scanning may be adversely affected by direct sunlight or the brightness of the surrounding light.   | Perform barcode scanning away from direct sunlight. Try adjusting the brightness of the surrounding light when scanning indoors.   |



## 3.2 Numeric Data Entry

Enter numeric data such as product volume with the numeric keys and Enter (ENT) key.

If numeric data is entered incorrectly, use the backspace key (BSPC) to delete the data and then reenter with the numeric keys.

| When Entering "120"  | Key Operation   |
|--|---|
| Press numeric keys <b>1</b> , <b>2</b> , and <b>0</b> followed by the Enter key. |     |

## 3.3 Task Selection

If a selection item "such as "1:XXX 2:XXX" with numeric values displays, enter the values with the numeric entry keys and then press the Enter key.

| When Selecting Task 2:XXX                             | Key Operation   |
|---|---|
| Press numeric key <b>2</b> followed by the Enter key. |   |

If a YES/NO selection screen such as "1:YES 2:NO" displays, press numeric key [1] to select "YES", and [2] to select "NO".

| When Selecting "1:YES"                                | Key Operation   |
|---|---|
| Press numeric key <b>1</b> followed by the Enter key. |   |

## 3.4 Changing the Default Settings

The buzzer volume, vibrator, LCD display brightness and power save settings can be changed at the MENU screen.

| Item           | Details   | Setting                             |
|----------------|---|-------------------------------------|
| BUZZER VOLUME  | Used to set the volume of the buzzer that notifies the user when barcode scanning is complete.<br>The volume can be adjusted in 4 levels: Hi, Lo, Mid and Mute. | Mute→Lo→Mid→Hi                      |
| VIBRATOR       | Used to turn ON/OFF the vibrator that notifies the user when barcode scanning is complete.  | ON, OFF                             |
| BRIGHTNESS     | Used to set the backlight brightness of the LCD display.<br>The brightness can be adjusted in 5 levels.   | Levels 1 to 5                       |
| BRIGHTNESS(PS) | Used to set the backlight brightness of the LCD display during power save mode. The brightness can be adjusted in 6 levels.                                     | Levels 0 to 5                       |
| POWER SAVE     | Used to set the time until the LCD display backlight is dimmed when not in use in order to save power.  | 1-second units<br>(max. 30 seconds) |

### 3.4.1 Procedure

1. Press **MENU** key

The MENU screen displays



2. Use the [▲] and [▼] cursor keys to select the item to be changed.

The selected item is highlighted.

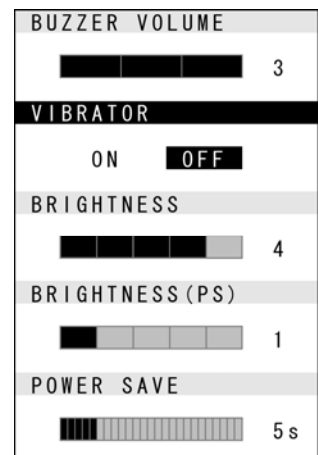

3. Use the [◀] and [▶] cursor keys to select the setting.

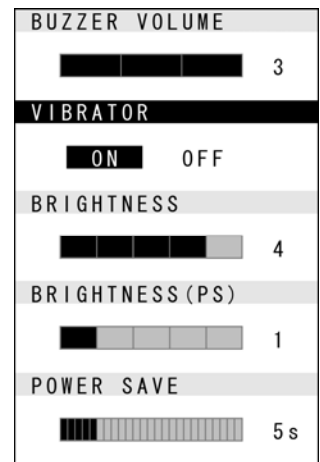

4. Press **MENU** key to exit the settings screen.



The settings screen is exited.

- 
- Point –
- Press the **MENU** key once again to terminate during operation.
  - The **MENU** key can be assigned to other keys such as the **SF** or **ENT** keys. To do this, press the **MENU** key while holding down the **SF** key.
-

## 3.5 Transmitting Data

Data gathered by the BHT can be transmitted to the host computer by connector communication, infrared communication and wireless communication\*.

The data transmission method and BHT setting method will differ depending on the system used, and therefore the system administrator should be contacted for details of operation.

### Request

Data gathered by the BHT should be promptly uploaded to the host computer.

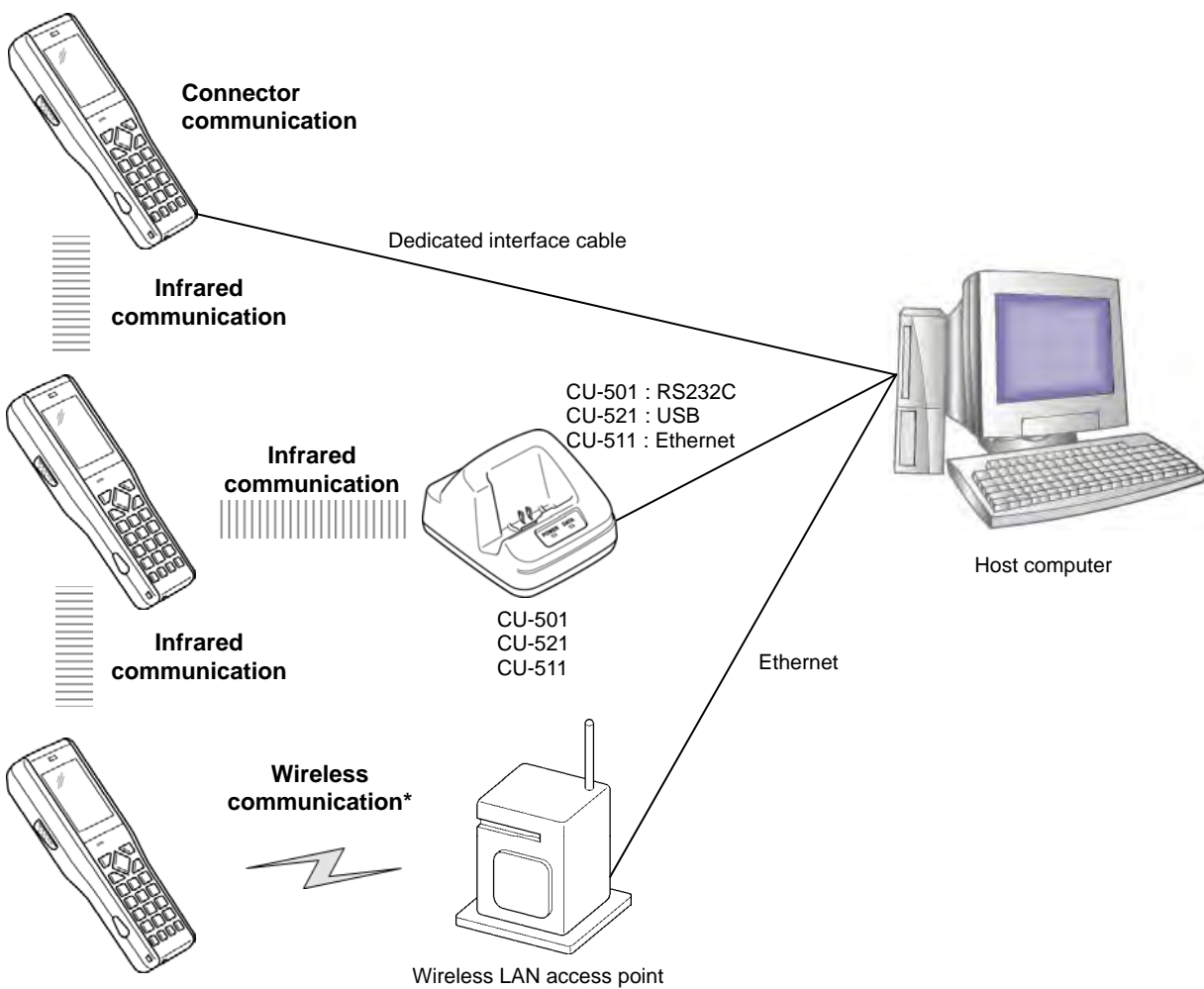

\* BHT-504BW only

To perform wireless communication with a wireless LAN access point, it is necessary to configure the wireless local area network (wireless LAN) at the BHT and access point.

### 3.5.1 Connector Communication

Connect the host computer and BHT with a dedicated interface cable (Option, Type: CBBHT-RS1000/3-9-02) and perform data communication.

The BHT-BASIC 4.0 Development Pack (Option) and BHT-BASIC 4.0 Transfer Utility (Option) software is required.

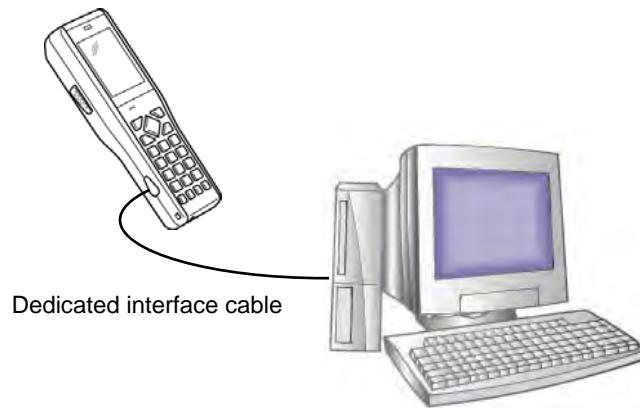

#### Requests

- Do not use a cable other than the dedicated interface cable.
- Avoid disconnecting and reconnecting the cable more than once a day. Disconnecting and reconnecting the cable too frequently will shorten the lifetime of the connector interface port. Use the communication unit (CU-501, CU-521 or CU-511) when it is necessary to perform frequent communication between the host computer and BHT.
- Avoid inserting the connector at an angle or pulling the cable strongly.

### 3.5.2 Infrared Communication

#### ◆ When performing data communication between BHT units

Point the BHT infrared communication ports toward each other and perform communication.



#### Requests

- Ensure that the light path between the BHT and any target stations is not obstructed.
- Perform communication within the effective infrared emission range (15 cm).
- Do not operate remote control units for televisions and so forth in the vicinity of infrared communication. This may result in communication failure.
- Perform communication in locations where the BHT units will not be exposed to light interference from sources such as intense ambient lighting (inverter-driven fluorescent lighting, in particular) or direct sunlight. This may result in communication failure.

#### ◆ When performing data communication with the host computer

Data can be transmitted directly to the host computer if the computer is equipped with an infrared communication port.

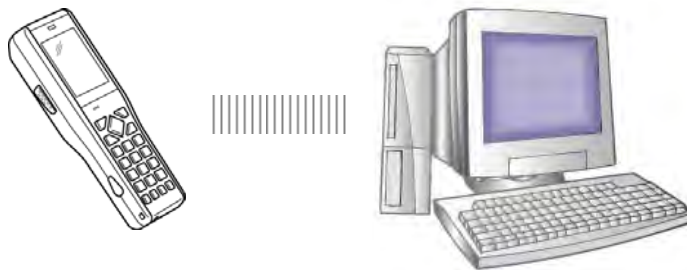

If the host computer is not equipped with an infrared communication port, place the BHT on the communication unit (CU-501, CU-521 or CU-511) and transmit data.

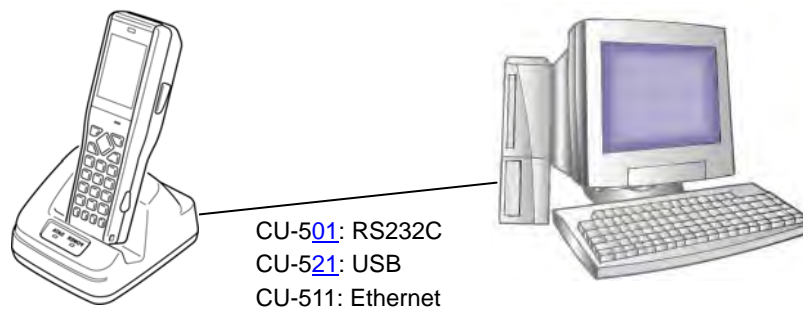

### 3.5.3 Wireless Communication

\* BHT-504BW only

Transmit data to host computer via the wireless LAN access point.

To perform wireless communication, it is necessary to configure the wireless local area network (wireless LAN) at the BHT and access point.

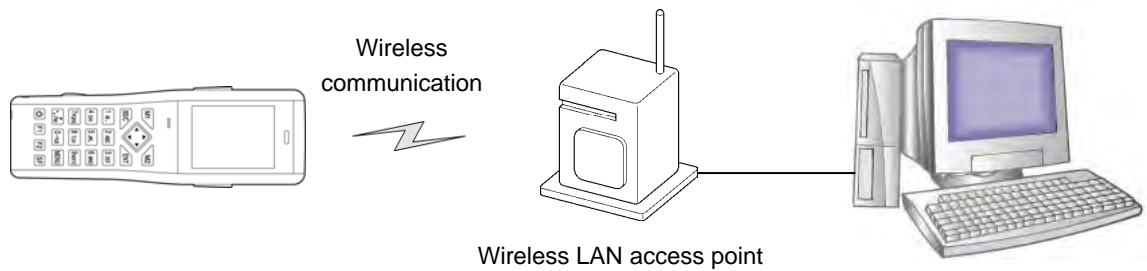

#### Requests

- Point the antenna on top of the BHT toward the access point to improve communication performance.
- Communication may not be possible at the following locations.
  1. In the vicinity of devices operating on the same 2.4 GHz waveband as the BHT such as microwave ovens, industrial heating equipment, or high-frequency medical equipment.
  2. In the vicinity of computers or household appliances such as refrigerators that emit electromagnetic noise.
  3. In the vicinity of metallic objects, in places with high levels of metallic dust, in rooms surrounded by metal walls (metallic influence), or places where the BHT may be subject to strong impact.

## **Chapter 4**

# **System Operation**

This chapter describes how to initialize and update the system, start up a user program, and operate System Mode.

|        |  |     |
|--------|--|-----|
| 4.1    | Initializing the BHT System  | 40  |
| 4.1.1  | Selecting the Memory Area to be Initialized  | 41  |
| 4.1.2  | Selecting the Message Version (English or Japanese)  | 42  |
| 4.1.3  | Confirming the Memory Area Selected for Initialization   | 42  |
| 4.1.4  | Performing System Initialization   | 43  |
| 4.2    | Updating the System  | 44  |
| 4.2.1  | Updating the BHT System  | 44  |
| 4.2.2  | CU-511 System Update<br>(when Equipped with LAN Communication Software)  | 45  |
| 4.3    | Executing User Programs  | 46  |
| 4.3.1  | Executing from the SYSTEM MENU "EXECUTE PROGRAM"   | 46  |
| 4.3.2  | Automatically Executing the Program Set at the SYSTEM MENU<br>when Turning the Power ON                              | 46  |
| 4.3.3  | Executing the First Registered Program by Turning the Power ON<br>(BHT System Directory Management Program Function) | 46  |
| 4.3.4  | Executing by Wake-up   | 48  |
| 4.3.5  | Executing by Remote Wake-up  | 48  |
| 4.4    | System Mode  | 49  |
| 4.4.1  | Starting Up System Mode  | 49  |
| 4.4.2  | System Mode Basic Operation  | 50  |
| 4.4.3  | SYSTEM MENU Configuration  | 52  |
| 4.5    | SYSTEM MENU  | 60  |
| 4.5.1  | Executing User Programs (EXECUTE PROGRAM Menu)   | 60  |
| 4.5.2  | Downloading Files (DOWNLOAD Menu)  | 61  |
| 4.5.3  | Uploading Files (UPLOAD Menu)  | 64  |
| 4.5.4  | Copying Files between 2 BHT Units  | 67  |
| 4.5.5  | System Environment Settings (SET SYSTEM Menu)  | 70  |
| 4.5.6  | BHT Operation Test (TEST Menu)   | 93  |
| 4.5.7  | System Information (SYSTEM INFORMATION Menu)   | 112 |
| 4.5.8  | Downloading/Uploading Files by FTP (FTP MENU)  | 115 |
| 4.5.9  | Wireless Communication Settings (RF MENU)  | 121 |
| 4.5.10 | Deleting Program/Data Files (DELETE FILE Menu)   | 138 |
| 4.5.11 | Deleting Font Files (DELETE FILE Menu)   | 139 |
| 4.5.12 | Downloading/Uploading the BHT System Parameter File<br>(SYSTEM PARAMETER Menu)                                       | 141 |
| 4.5.13 | Setting the Remote Wake-up (SET REMOTE WAKEUP Menu)  | 144 |
| 4.5.14 | Downloading/Uploading the System Message File<br>(SYSTEM MESSAGE Menu)   | 145 |
| 4.5.15 | Updating the System (MODIFY MENU)  | 148 |



## 4.1 Initializing the BHT System

By initializing the system, program files and data files downloaded to the BHT user area are deleted, and system settings are returned to the default status when shipped from the factory.

The system must be initialized when:

- Deleting all program files and data files downloaded to the BHT user area (Font files are also deleted by selecting the area subject to initialization.)
- The following message displays on the screen when the BHT is turned on.

```
Contact your
      administrator.
Note the error
      number.
(2XXX)
```

- 
- Point -** By initializing the system, all files in the user area are deleted, and therefore all files that need to be backed up should be uploaded to the host computer and so on beforehand.  
Refer to section “4.5.3 Uploading Files (UPLOAD Menu)” for details of uploading.
- 

The initialization procedure is described on the following pages.  
Perform operation in accordance with the procedure for each item.

- v Selecting the Memory Area to be Initialized  
↓
- v Selecting the Message Version (English or Japanese)  
↓
- v Confirming the Memory Area to be Selected for Initialization  
↓
- v Performing System Initialization

## 4.1.1 Selecting the Memory Area to be Initialized

1. Press the **Power** key (  ) while holding down the **SF**, **M1** and **0** keys together.

The screen on the right displays.

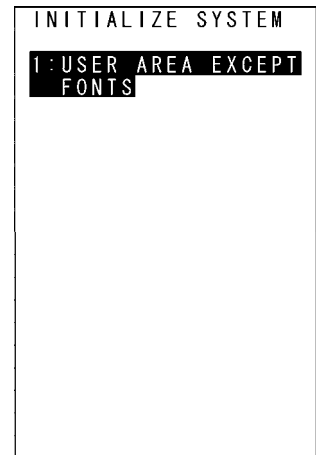

2. Select the memory area to be initialized.

**(1) To exempt font files from deletion:**

Ensure that "1:USER AREA EXCEPT FONTS" is selected and press the **ENT** key.

The screen changes to the "4.1.3 Confirming the Memory Area Selected for Initialization".

**(2) To delete font files:**

Press the **2** key while holding down the **SF** key.

The screen on the right displays.

Next, press the **2** key, select "2:WHOLE USER AREA", and press the **ENT** key.

The screen changes to the "4.1.2 Selecting the Message Version (English or Japanese)".

"1: USER AREA EXCEPT FONTS"

The user area is initialized without deleting file fonts.

"2: WHOLE USER AREA"

The entire user area is initialized and therefore file fonts are also deleted.

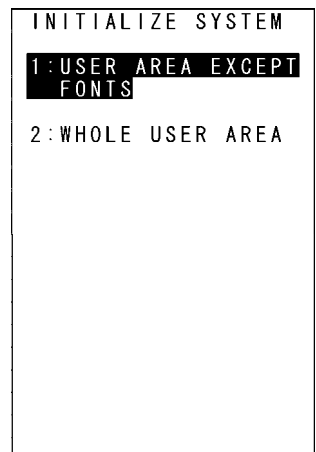

---

- Point - If a "Contact the administrator. (2XXX)" message displays when the BHT power is ON, select "2: WHOLE USER AREA".

---

### 4.1.2 Selecting the Message Version (English or Japanese)

1. When the screen on the right displays, select the message display language with the numerical keys.

“1: Japanese”      Changes the message language to Japanese.  
 “2: English”        Changes the message language to English.

2. Press the **ENT** key.

Proceed to the operation at section “4.1.3 Confirming the Memory Area Selected for Initialization”.

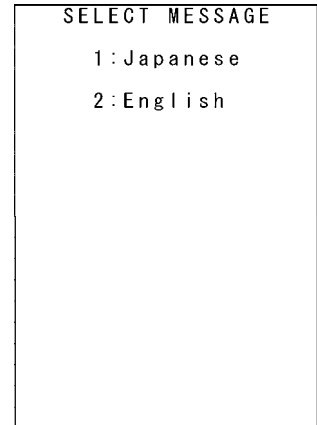

### 4.1.3 Confirming the Memory Area Selected for Initialization

- (1) To exempt font files from deletion:

When the screen on the right displays, select the item and press the **ENT** key.

Press and hold the **BS/C** key to return to the screen to select the area for initialization.

“1: Yes”:  
 The system will be initialized without deleting font files.  
 “2: No”:  
 Cancels system initialization and turns the BHT power OFF.

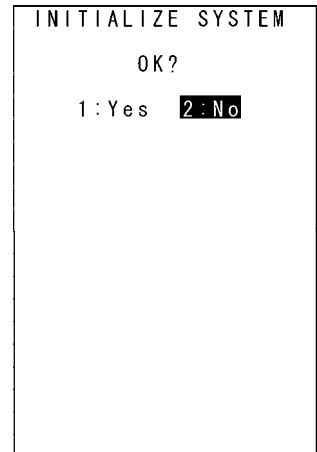

- (2) To delete font files:

When the screen on the right displays, select the item and press the **ENT** key.

Press and hold the **BS/C** key to return to the screen to select the area for initialization.

“1: Yes”:  
 The system will be initialized, and all files in the user area, including font files, will be deleted.  
 “2: No”:  
 Cancels system initialization and turns the BHT power OFF.

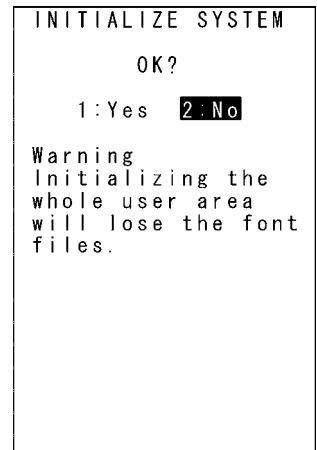

## 4.1.4 Performing System Initialization

1. The screen on the right displays during system initialization.

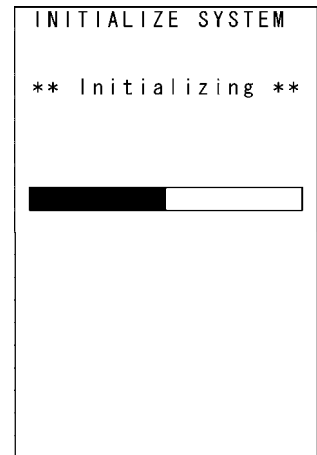

2. Upon completion of system initialization, the BHT displays the screen on the right for a second and then turns OFF automatically.

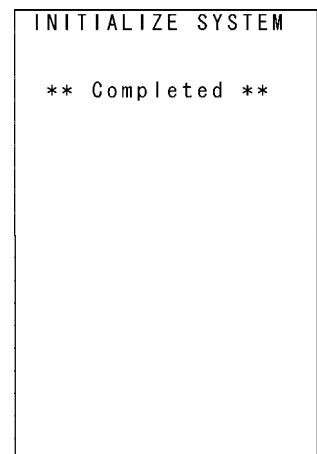

- 
- Point -
- Never turn OFF the BHT power during system initialization. Turning the power OFF too early will interrupt the process, requiring initialization to be performed again.
  - If a "Contact your administrator. Note the error number. (XXXX)" message displays even although initialization has been completed, initialize the BHT again.
  - Following initialization, all programs and data files stored in the target memory area will be lost. Download them again if necessary. (Refer to section "4.5.2 Downloading Files (DOWNLOAD Menu)" for details of downloading.)
  - Always set the calendar clock following initialization. (Refer to "Chapter 2 BHT Preparation" – "2.4 Initial Setup".)
  - Initialization will restore the display contrast level, communication conditions and other settings to their default values when shipped from the factory, and therefore they should be edited if necessary.
-

## 4.2 Updating the System

### 4.2.1 Updating the BHT System

The BHT system update procedure is as follows.

BHT System Update File Download  
↓  
BHT System Update

#### ◆ BHT System Update File Download

Refer to sections “4.5.2 Downloading Files (DOWNLOAD Menu)” and “4.5.8 Downloading/Uploading Files by FTP (FTP MENU)”, and download the BHT system update file to the BHT.

---

- **Note** - The BHT system update file can be downloaded from the following Web site.  
<http://www.qbdirect.net/>

---

#### ◆ BHT System Update

Refer to section “4.5.15 Updating the System (MODIFY MENU)” and update the BHT system.

---

- **Important** - In order to prevent the battery running low during the system update process, perform the system update with the battery sufficiently charged, or with the BHT placed in the CU-500 Series. If the BHT power turns OFF due to a low battery and so on during the system update, the system update will continue when the power is next turned ON. Furthermore, during system update, the power will not turn OFF even if the **Power** key (⏻) is pressed. Wait until the system update process is complete before operating the BHT.

---

## 4.2.2 CU-511 System Update (when Equipped with LAN Communication Software)

The CU-511 system update procedure is as follows.

CU-511 System Update File Download  
↓  
CU-511 System Update

### ◆ CU-511 System Update File Download

Refer to sections "4.5.2 Downloading Files (DOWNLOAD Menu)" and "4.5.8 Downloading/Uploading Files by FTP (FTP MENU)", and download the CU-511 system update file to the BHT.

Download the CU-511 system update file as a data file with field length of 64 bytes.

---

**- Important -** If the Transfer Utility is used to download in BHT protocol, select the "Perform binary file transfer (F)" check box at the Transfer Utility Options screen and then download.

---



---

**- Note -** The CU-511 system update file can be downloaded from the following Web site.  
<http://www.qbdirect.net/>

---

### ◆ CU-511 System Update

Refer to section "4.5.15 Updating the System (MODIFY MENU)" and update the CU-511 system.

The CU-511 LED flashes during CU-511 system update.

---

**- Important -** Never remove the BHT from the CU-511 or turn the BHT power OFF during the system update process.

If the BHT is removed from the CU-511 or the BHT power turned OFF during system update, a system update error will occur, and the CU-511 will wait for the update to be retried.

In such a case, either perform the CU-511 system update again, or reboot the CU-511.

---

**- Point -** If the CU-511 power is turned OFF during the system update, when the power is next turned ON, either the system prior to updating or system after updating will run.

The system running can be verified at the CU-511 System Information display.  
(Refer to section "4.5.7 System Information (SYSTEM INFORMATION Menu)" for details.)

---

## 4.3 Executing User Programs

User programs (application programs) can be executed using the following methods.  
Select the most appropriate method to meet the objective.

### 4.3.1 Executing from the SYSTEM MENU “EXECUTE PROGRAM”

Select the program to be executed at the SYSTEM MENU “EXECUTE PROGRAM” menu.  
In such a case, the selected program will always be executed from the start.  
Refer to section “4.5.1 Executing User Programs (EXECUTE PROGRAM Menu)” for details.

### 4.3.2 Automatically Executing the Program Set at the SYSTEM MENU when Turning the Power ON

Select the program to be executed at the SYSTEM MENU “EXECUTE PROGRAM” menu, and then turn the BHT power OFF. The selected program will be executed automatically the next time the BHT power is turned ON.

If the resume function has been set, the BHT will resume from the position in the program that was stopped when the BHT power was last turned OFF.

Refer to section “4.5.5 System Environment Settings (SET SYSTEM Menu)” for details.

### 4.3.3 Executing the First Registered Program by Turning the Power ON (BHT System Directory Management Program Function)

If no program has been selected at the SYSTEM MENU “EXECUTE PROGRAM” menu and the BHT power is turned ON, control will switch to the directory management program, and the first of the programs (.PD4) registered in the BHT will be executed.

If the resume function has been set, the BHT will resume from the position in the program that was stopped when the BHT power was last turned OFF.

If downloading multiple programs after system initialization, programs are registered in the system in the order in which they are downloaded, and therefore ensure that the program to be executed is the first program downloaded.

If a program is later downloaded for the purpose of upgrading the version, use the same program name. The order in which programs are registered in the system will not change, and therefore the same program will be executed even after upgrading the version. (\*)

\* The system directory management program also manages files with other extensions simultaneously. If the top file from the first registered program is deleted and a new program is downloaded, the new program will be registered in the position vacated by the deleted file and therefore caution is advised. It is recommended that the program to be executed after turning on the BHT power is first downloaded following system initialization.

Several directory management program examples are given below.  
The names of the files used in these examples are as follows.

- MAIN.PD4 : Program to be executed by pressing the **Power** key (⏻) only
- SUBMAIN.PD4 : Program chained from MAIN.PD4 using the BHT-BASIC CHAIN statement
- USER.PD4 : New program
- AAAAAAAA.DAT : Data file 1 used at the user program
- BBBBBBBB.DAT : Data file 2 used at the user program

◆ **(Example 1) When downloading the MAIN.PD4 and SUBMAIN.PD4 upgrade version**

In the above case, the registration order does not change and therefore MAIN.PD4 starts up by pressing the **Power** key (⏻).

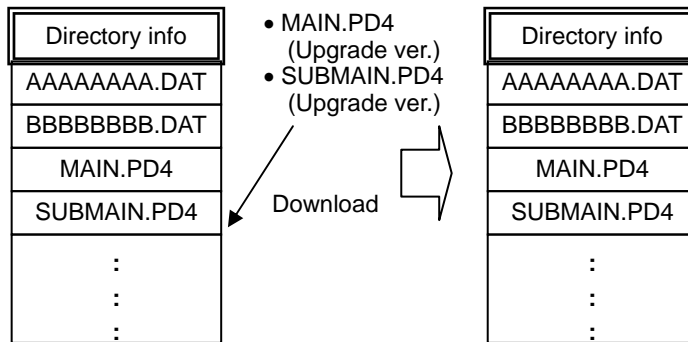

◆ **(Example 2) When newly downloading USER.PD4 after deleting BBBBBBBB.DAT**

In the above case, USER.PD4 is registered after BBBBBBBB.DAT, and therefore USER.PD4 will be the first registered program. Press the **Power** key (⏻) to start up USER.PD4.

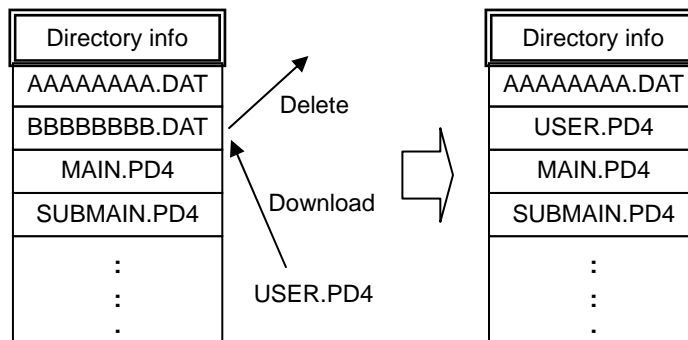





## 4.4 System Mode

By starting up the BHT in System Mode and selecting each menu, the following operations can be performed individually.

- Executing user programs
- File download/upload
- System environment setting
- BHT operation test
- System information display
- Downloading/uploading files by FTP ( \* BHT-504BW only)
- File deletion
- Font file deletion
- System settings parameter file download/upload
- Remote wake-up setting
- System message file download/upload
- System update

Refer to each item at the "4.5 SYSTEM MENU" for details of the above operations.

### 4.4.1 Starting Up System Mode

Use the following procedure to start up System Mode.

1. Press the **Power** key (🔌) while holding down the **SF** and **1** keys.

System Mode starts up and the SYSTEM MENU (screen on right) displays.

Select and display each menu from the SYSTEM MENU and perform each operation.

Press and hold the **SF** key and press the appropriate numerical key to display items not displayed at the SYSTEM MENU.

Refer to "4.4.3 SYSTEM MENU Configuration" for details.

| BHT-503B  | BHT-504BW  |
|---|--|
| SYSTEM MENU<br>1: EXECUTE PROGRAM<br>2: DOWNLOAD<br>3: UPLOAD<br>4: SET SYSTEM<br>5: TEST<br>6: VERSION<br>7: FTP | SYSTEM MENU<br>1: EXECUTE PROGRAM<br>2: DOWNLOAD<br>3: UPLOAD<br>4: SET SYSTEM<br>5: TEST<br>6: VERSION<br>7: FTP<br>8: RF |

## 4.4.2 System Mode Basic Operation

### Menu Selection and Display

Use the following procedure to select and display each menu.

1. Press the numerical key corresponding to the menu to be selected.  
Alternatively, press the cursor keys ([▲] [▼]) to select the menu.

The selected menu item will be highlighted.  
"EXECUTE PROGRAM" will be highlighted when System Mode is started up.

2. Press the **ENT** key.

The selected item is set and the next screen displays.

Press the **BS/C** key while holding down the **SF** key to return to the previous screen.

The selected item will be highlighted when returning to the previous screen.

3. Repeat the above operation to display the target menu.

### ◆ Operation example (Screen display: BHT-504BW)

Select [4: SET SYSTEM] with the [4] or [▲]/[▼] keys.

Select [5: COMMUNICATION] with the [5] or [▲]/[▼] keys.

Select [3: COM PORT] with the [3] or [▲]/[▼] keys.

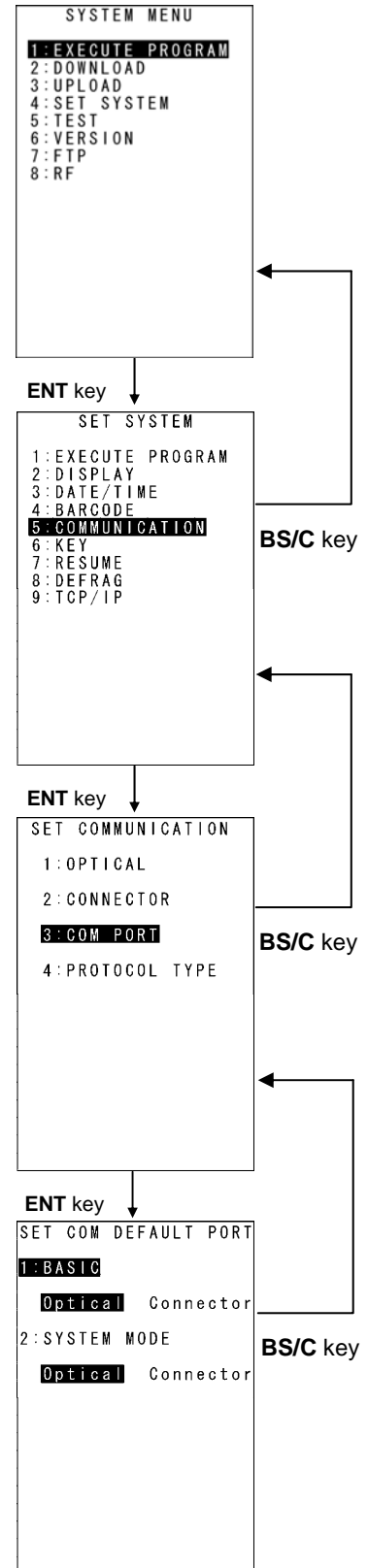

### Setting Value Selection

Use the following procedure to select setting values.

1. Press the numerical key corresponding to the item to be selected.  
Alternatively, press the cursor keys ([▲] [▼]) to select the item.

The selected item will be highlighted.

2. Select the setting value with the cursor keys ([◀] [▶]).

3. Press the **ENT** key.

The selected setting value will be set.

### ◆ Operation example

```
SET COM DEFAULT PORT
1: BASIC
  Optical Connector
2: SYSTEM MODE
  Optical Connector
```

Select the setting item with the [2] key or [▲]/[▼] keys.

```
SET COM DEFAULT PORT
1: BASIC
  Optical Connector
2: SYSTEM MODE
  Optical Connector
```

Select the setting value with the cursor keys ([◀] [▶]).

```
SET COM DEFAULT PORT
1: BASIC
  Optical Connector
2: SYSTEM MODE
  Optical Connector
```

ENT key

```
SET COMMUNICATION
1: OPTICAL
2: CONNECTOR
3: COM PORT
4: PROTOCOL TYPE
```

### 4.4.3 SYSTEM MENU Configuration

#### 4.4.3.1 Menu Configuration for Items Displayed at the SYSTEM MENU Screen

Select the item with the numerical keys or cursor keys ([▲] [▼]) and press the ENT key.

##### BHT-500B Menu Configuration

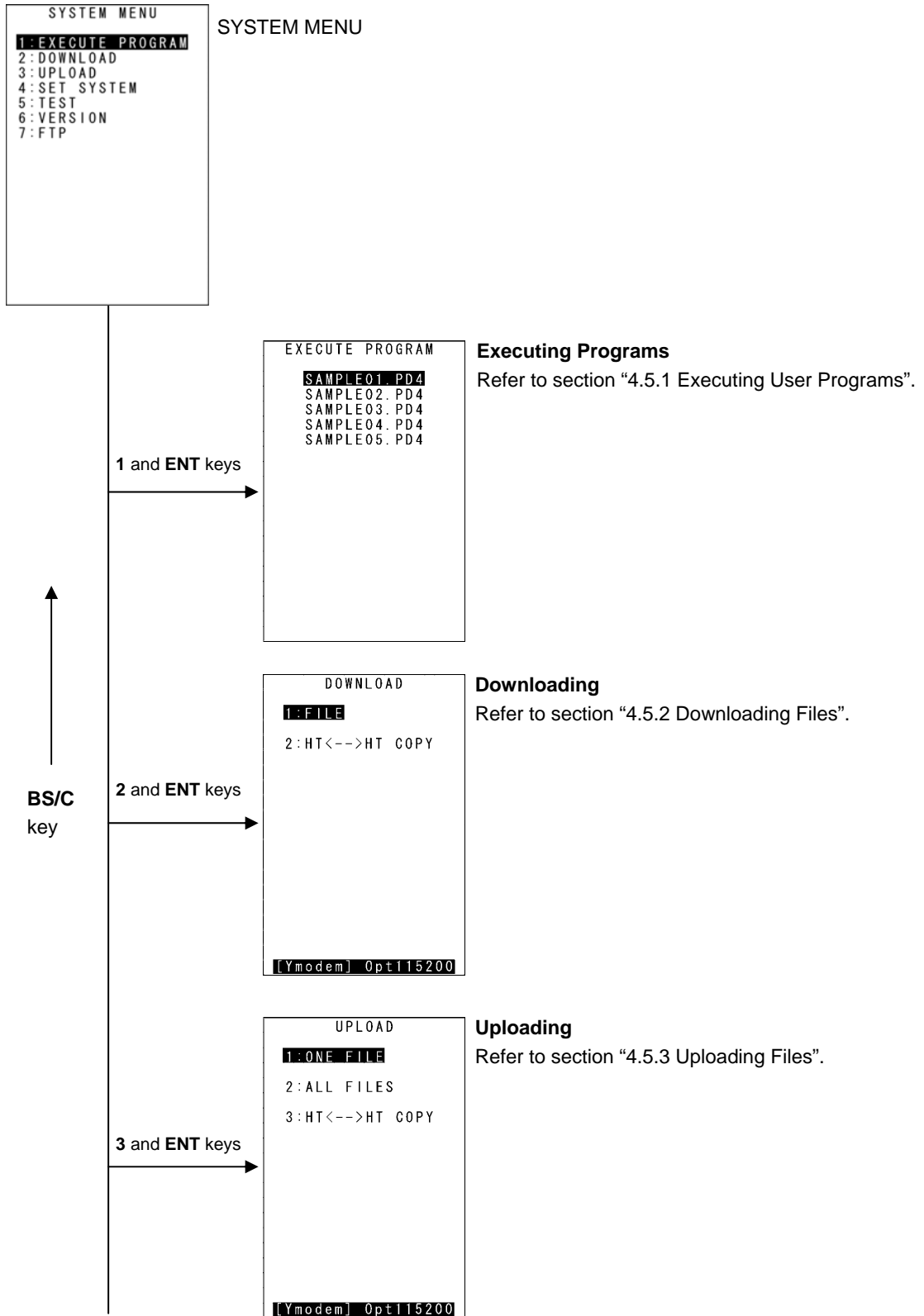

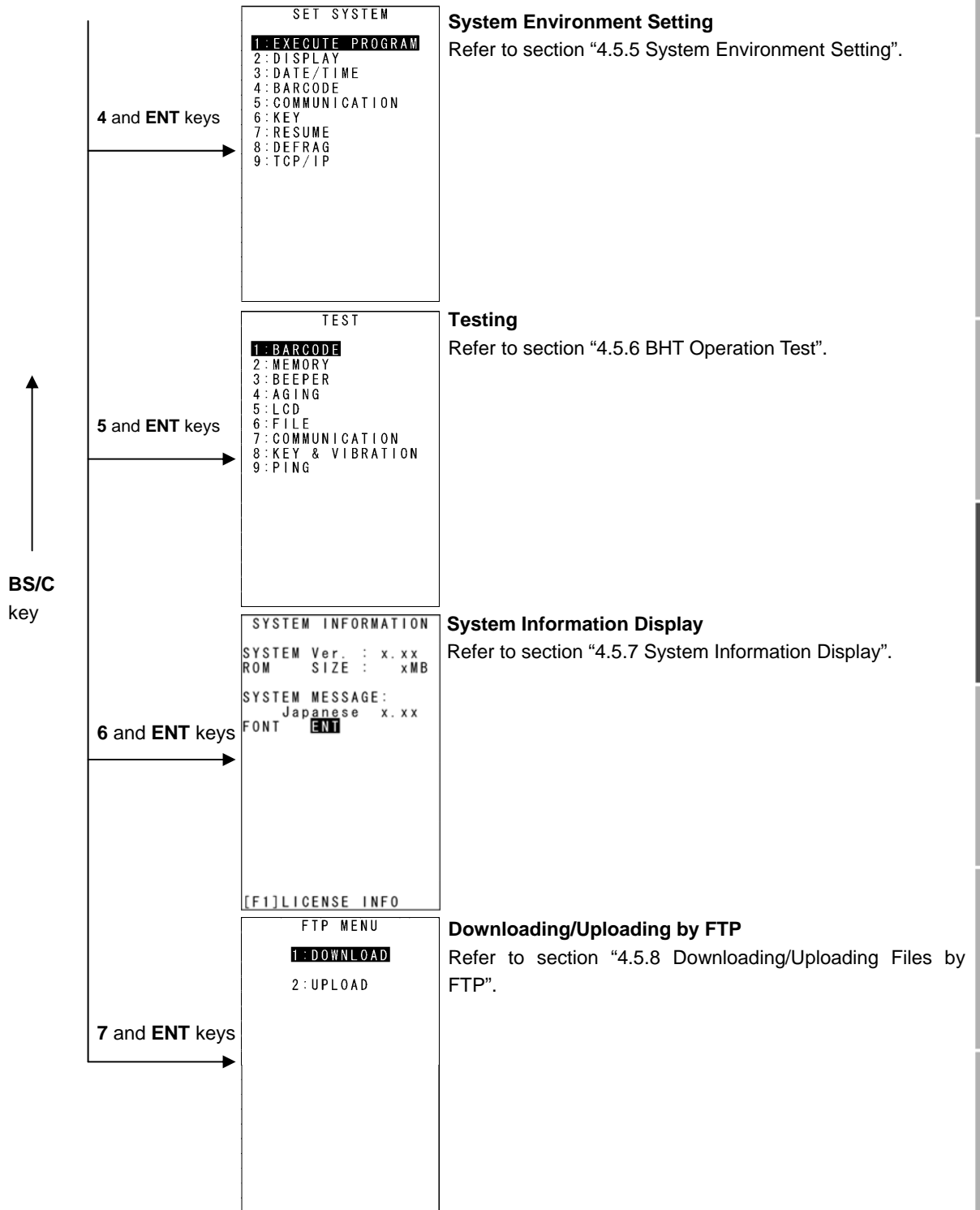

BHT-504BW Menu Configuration

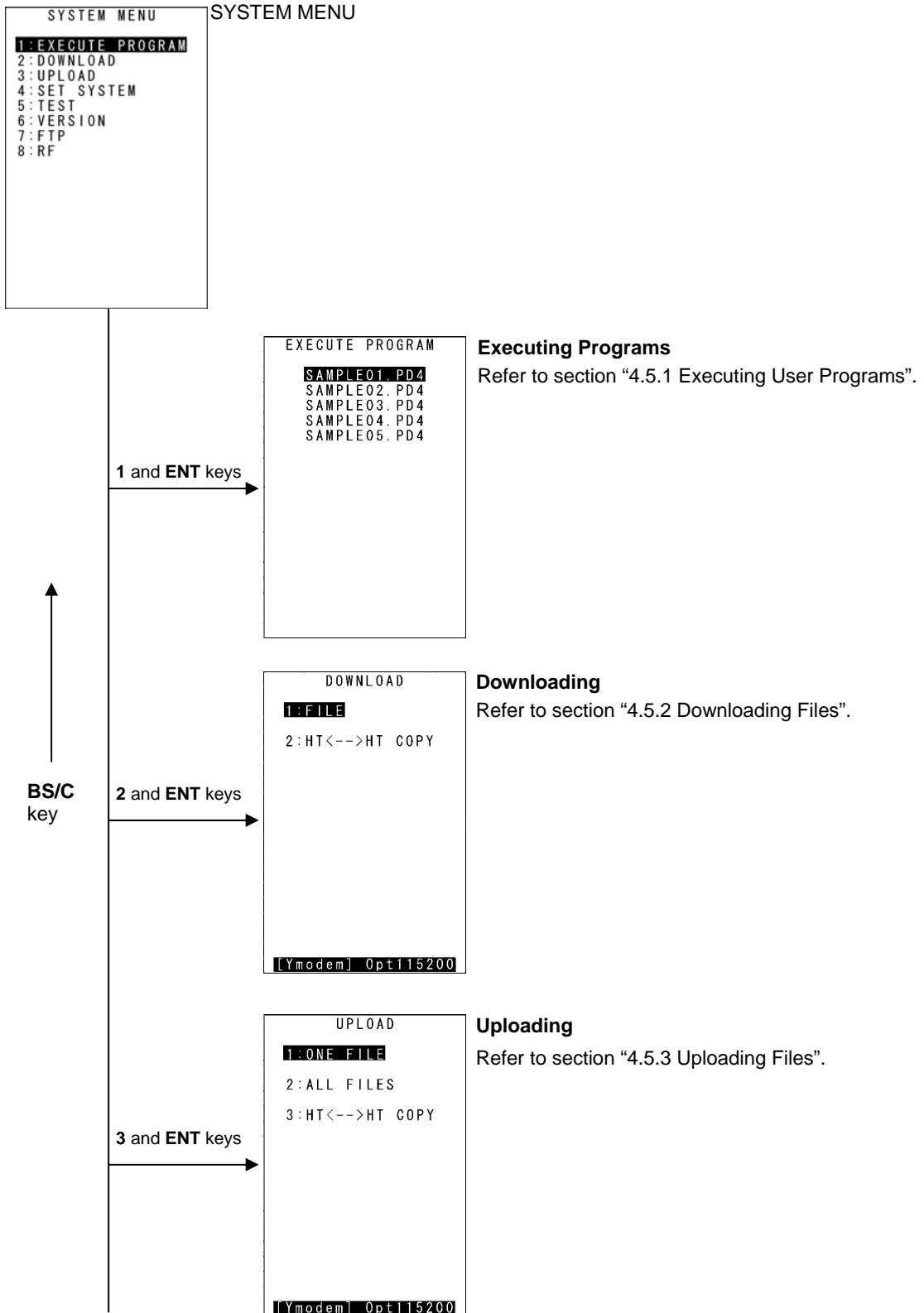

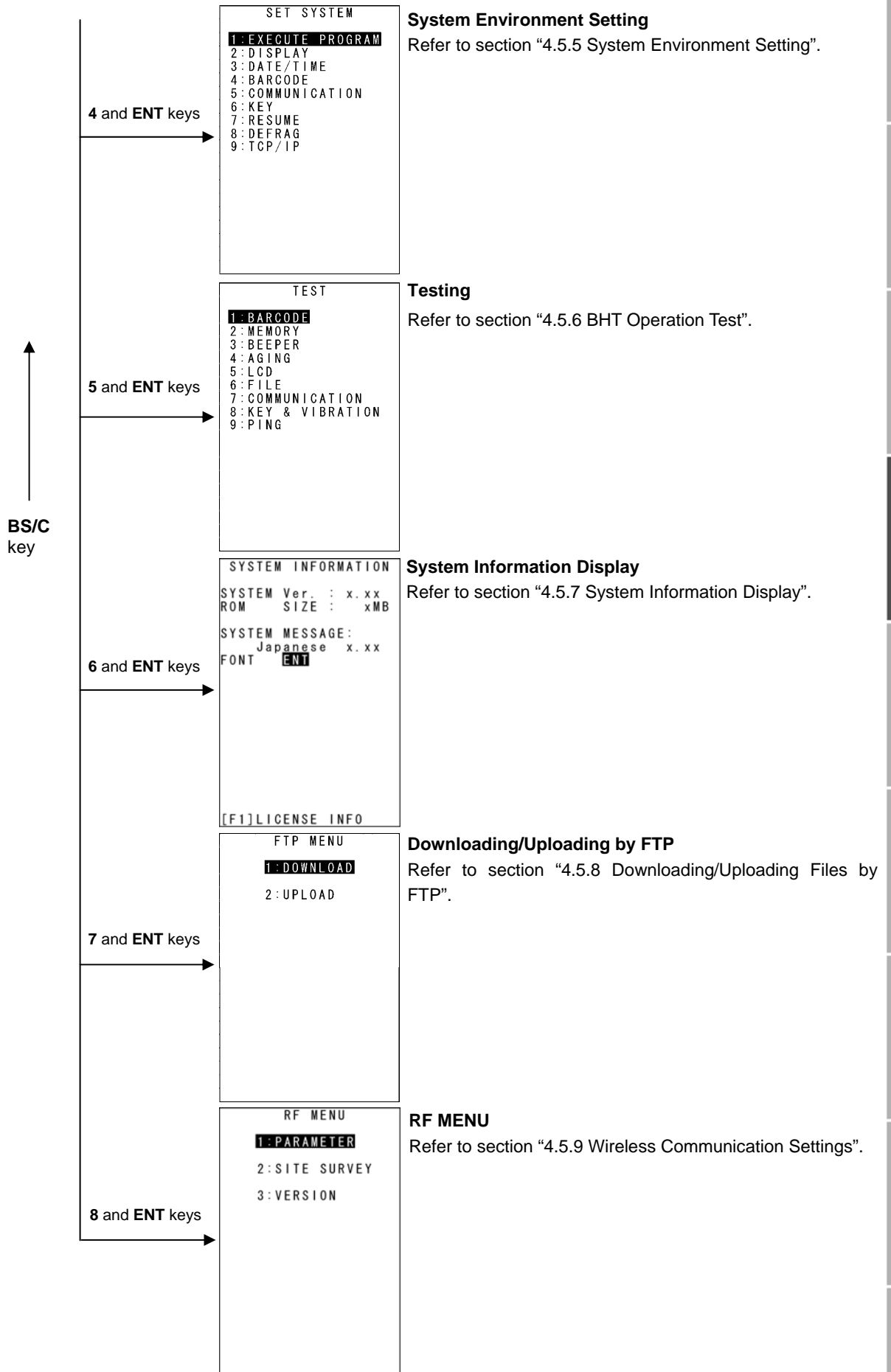



### 4.4.3.2 Menu Configuration for Items Not Displayed at the SYSTEM MENU Screen

Press the corresponding numerical key while holding down the **SF** key.

#### BHT-500B Menu Configuration

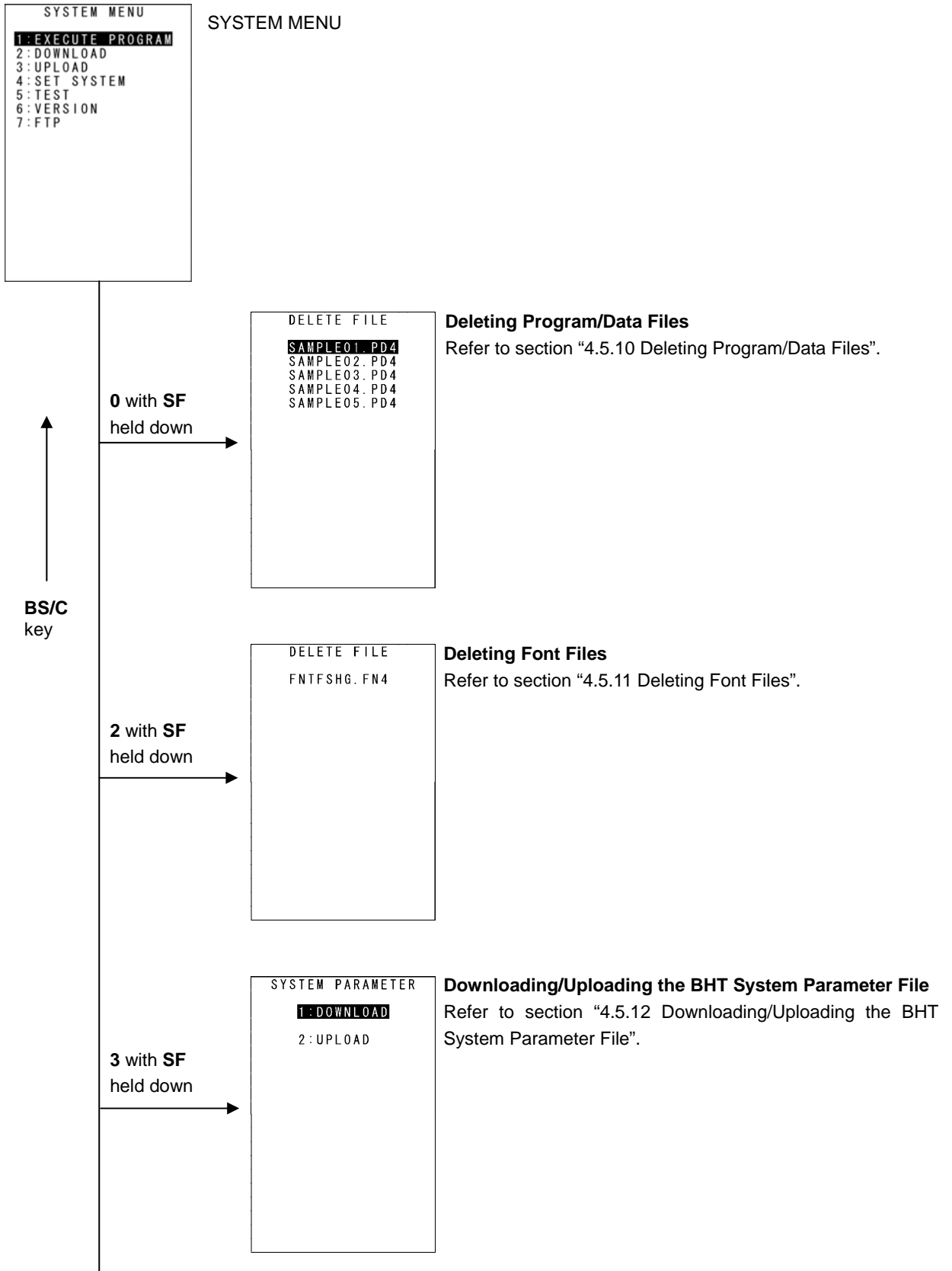

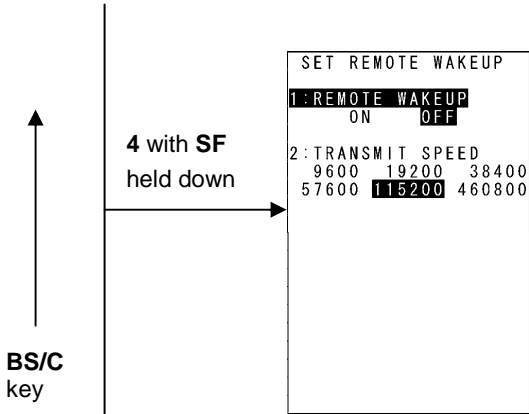

**Setting Remote Wake-up**

Refer to section "4.5.13 Setting Remote Wake-up".

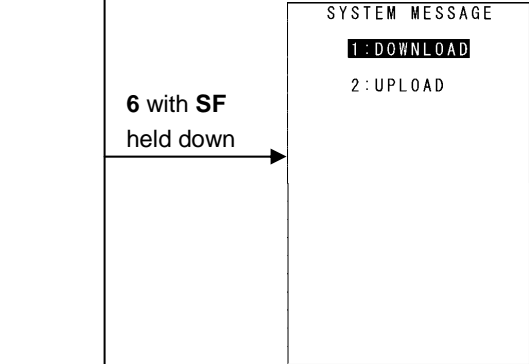

**Downloading/Uploading the System Message File**

Refer to section "4.5.14 Downloading/Uploading System the Message File".

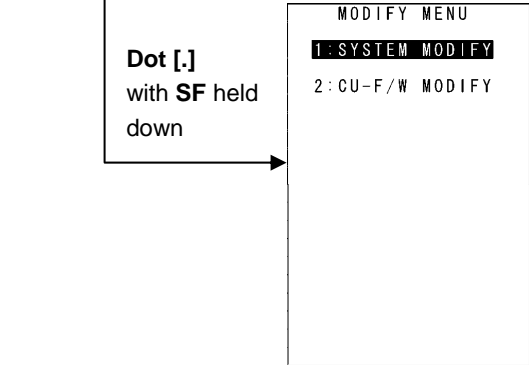

**Updating the System**

Refer to section "4.5.15 Updating the System".

Outline

BHT Preparation

Basic Operation

System Operation

Communication

Maintenance

Error Messages

Specifications

Appendices

BHT-504BW Menu Configuration



SYSTEM MENU

BS/C key

0 with SF held down

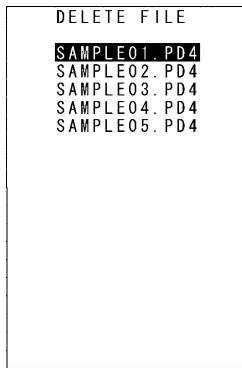

Deleting Program/Data Files

Refer to section "4.5.10 Deleting Program/Data Files".

2 with SF held down

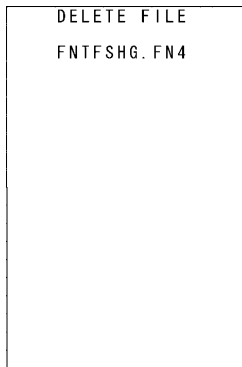

Deleting Font Files

Refer to section "4.5.11 Deleting Font Files".

3 with SF held down

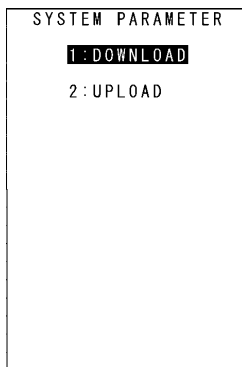

Downloading/Uploading the BHT System Parameter File

Refer to section "4.5.12 Downloading/Uploading the BHT System Parameter File".

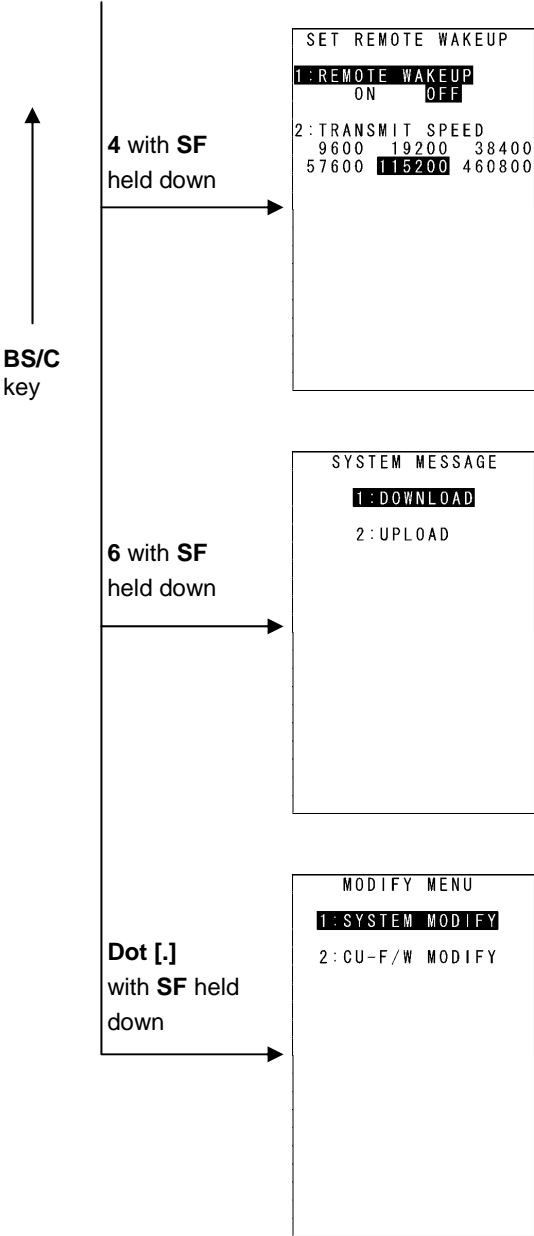

```
SET REMOTE WAKEUP
1: REMOTE WAKEUP
   ON      OFF
2: TRANSMIT SPEED
   9600   19200  38400
   57600  115200  460800
```

**Setting Remote Wake-up**

Refer to section "4.5.13 Setting Remote Wake-up".

```
SYSTEM MESSAGE
1: DOWNLOAD
2: UPLOAD
```

**Downloading/Uploading the System Message File**

Refer to section "4.5.14 Downloading/Uploading System the Message File".

```
MODIFY MENU
1: SYSTEM MODIFY
2: CU-F/W MODIFY
```

**Updating the System**

Refer to section "4.5.15 Updating the System".

# 4.5 SYSTEM MENU

## 4.5.1 Executing User Programs (EXECUTE PROGRAM Menu)

Individually select and execute user programs downloaded to the BHT.  
Use the following procedure to execute user programs.

1. Select "1: EXECUTE PROGRAM" at the SYSTEM MENU and then press the **ENT** key.

The screen on the right displays.  
Press and hold the **BS/C** key to return to the SYSTEM MENU.

```
EXECUTE PROGRAM
SAMPLE01.PD4
SAMPLE02.PD4
SAMPLE03.PD4
SAMPLE04.PD4
SAMPLE05.PD4
```

2. Use the cursor keys ([▲] [▼]) to select the target program.

The selected program will be highlighted.  
Use the [▼] key to scroll down when more than 18 programs have been downloaded to the user area.

The screen on the right shows an example in which 23 programs have been downloaded.

```
EXECUTE PROGRAM
SAMPLE18.PD4
SAMPLE19.PD4
SAMPLE20.PD4
SAMPLE21.PD4
SAMPLE22.PD4
SAMPLE23.PD4
```

3. When the target program is highlighted, press the **ENT** key.

The selected program will be executed.

The screen on the right displays when no program files exist in the user area.  
Press and hold the **BS/C** key to return to the SYSTEM MENU.

```
EXECUTE PROGRAM
*****
* NO FILE EXISTS *
*****
```

## 4.5.2 Downloading Files (DOWNLOAD Menu)

Download files to the BHT user area from other devices such as the host computer.

- Point -**
- If a file with the same name as one already used in the user area of the target memory in the BHT is downloaded, the newly downloaded file replaces the old one.
  - If an auto-start execution program has not been specified (See 4.5.5 [1] Auto-start Execution Program Settings), the directory management program will execute the first managed program from among the programs (.PD4) downloaded to the BHT when the BHT power is turned ON. (Program displayed at the top of the “EXECUTE PROGRAM” menu) Take this into account when determining the file download order. Refer to “4.3 Executing User Programs” for details.

Use the following procedure to download files.

1. Select “2: DOWNLOAD” at the SYSTEM MENU and then press the **ENT** key.

The screen on the right displays.

“1: FILE”:

Select to download a specific file.

“2: HT<-->HT COPY”:

Select to download a file from another BHT.

Refer to “4.5.4 Copying Files between 2 BHT Units” for details.

Press and hold the **BS/C** key to return to the SYSTEM MENU.

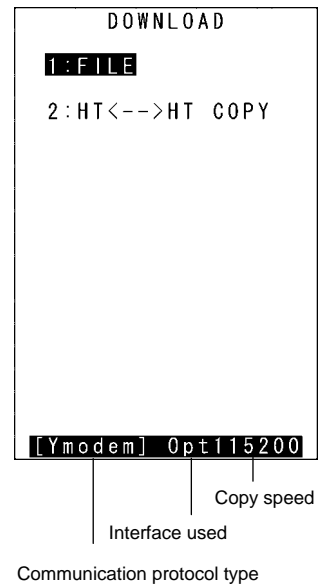

The current communication settings display at the bottom of the screen.

|                             |                          |  |
|-----------------------------|--------------------------|--|
| Communication protocol type | Ymodem<br>BHT-Ir<br>BHTp | Ymodem protocol<br>BHT-Ir protocol<br>BHT protocol |
| Interface used              | Opt<br>Con               | Infrared interface<br>Connector interface          |
| Copy speed                  | 300 to 460800            | Transmission speed corresponding to each protocol  |

Refer to “4.5.5 System Environment Settings (SET SYSTEM Menu)” for details of communication environment settings.

2. Select either "1: FILE" or "2: HT<-->HT COPY" and press the **ENT** key.

The screen on the right displays indicating that the BHT is waiting for the file to be downloaded.

The screen on the right displays only when "1: FILE" is selected.

If "2: HT<-->HT COPY" is selected, "HT<-->HT" displays in the center of the second row of the screen.

```
DOWNLOAD FILE
```

```
** Waiting **
```

3. By executing the BHT-BASIC 4.0 Transfer Utility or similar program, the screen on the right displays and file downloading is commenced.

(Refer to the "BHT-BASIC 4.0 Transfer Utility User's Guide.")

```
DOWNLOAD FILE
```

```
** Loading **
```

4. The screen on the right displays during downloading.

The screen on the right displays indicating the file name and the number of received records/the total number of records.

(When using the Ymodem protocol, the received file size/the total file size (units: KB) displays.)

Press the **BS/C** key to abort the download process and return to the DOWNLOAD menu.

```
DOWNLOAD FILE
```

```
XXXXXXXXX.XXX  
** Loading **
```

```
XXXXXXXX/YYYYYYY
```

5. When downloading is complete, the beeper sounds once and the screen on the right displays.

When the number of received records equals the total number of records, downloading is complete.

(When using the Ymodem protocol, the received file size equals the total file size.)

Press and hold the **BS/C** key to return to the DOWNLOAD menu.

With this screen is displayed on the BHT, downloading another new file from the host computer allows the BHT to begin receiving.

(Refer to the “BHT-BASIC 4.0 Transfer Utility User’s Guide.”)

```

DOWNLOAD FILE
XXXXXXXXX.XXX
** Completed **

```

If “2: HT<-->HT COPY” is selected, repeat the above operation until all files are downloaded.

If an error message (screen below) displays during downloading, refer to “Chapter 7 Error Messages”.

```

DOWNLOAD FILE
XXXXXXXXX.XXX
Out of memory

Retry?
1:Yes 2:No

```

```

DOWNLOAD FILE
XXXXXXXXX.XXX
Too many files

Retry?
1:Yes 2:No

```

```

DOWNLOAD FILE
XXXXXXXXX.XXX
Communication error

Retry?
1:Yes 2:No

```

```

DOWNLOAD FILE
XXXXXXXXX.XXX
Program file error

Retry?
1:Yes 2:No

```



### 4.5.3 Uploading Files (UPLOAD Menu)

Upload files stored in the BHT user area to another device.  
Use the following procedure to upload files.

1. Select “3: UPLOAD” at the SYSTEM MENU and then press the **ENT** key.

The screen on the right displays.

“1: ONE FILE”:

Select to upload a specific file.

“2: ALL FILES”:

Select to upload all files, excluding font files.

“3: HT<-->HT COPY”:

Select to upload a file to another BHT.

Refer to “4.5.4 Copying Files between 2 BHT Units” for details.

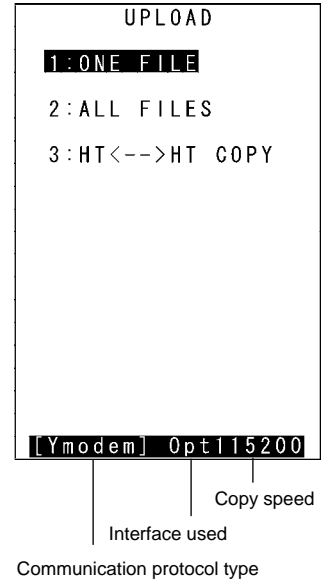

Press and hold the **BS/C** key to return to the SYSTEM MENU.

The current communication settings display at the bottom of the screen.

|                             |                          |  |
|-----------------------------|--------------------------|--|
| Communication protocol type | Ymodem<br>BHT-Ir<br>BHTp | Ymodem protocol<br>BHT-Ir protocol<br>BHT protocol |
| Interface used              | Opt<br>Con               | Infrared interface<br>Connector interface          |
| Copy speed                  | 300 to 460800            | Transmission speed corresponding to each protocol  |

Refer to “4.5.5 System Environment Settings (SET SYSTEM Menu)” for details of communication environment settings.

- **Point** - If BHT protocol or BHT-Ir protocol is selected for the communication protocol, BHT-BASIC 4.0\* specification files will not display at the file selection screen, and therefore cannot be downloaded.

(\*Applications with extension “.PD4”, extension libraries with extension “.FN4”, and data files that have any of the following structures: the number of fields is 17 or more, the total of the number of fields and each field length is 255 or more, and the number of records is 32768 or more)

2. Select "1: FILE", "2: ALL FILES" or "3: HT<-->HT COPY" and press the ENT key.

When "1: FILE" is selected:

The screen on the right displays. Select the file to be uploaded and press the ENT key.

Next, proceed to step 3.

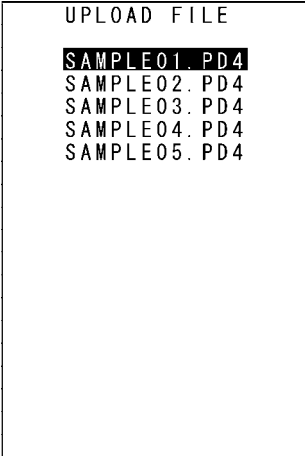

When "2: ALL FILES" or "3:HT<-->HT COPY" is selected:

Proceed to step 3.

The screen on the right displays if no files that can be uploaded exist in the user area.

Press and hold the BS/C key to return to the UPLOAD menu.

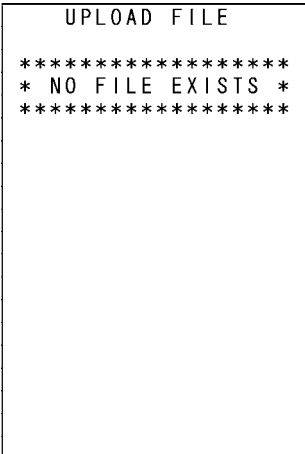

3. The screen on the right displays indicating that the BHT is waiting for the file to be uploaded.

The screen on the right displays only when "1: FILE" is selected.

If "2:ALL FILES" is selected, "ALL" displays in the center of the second row of the screen.

If "3: HT<-->HT COPY" is selected, "HT<-->HT" displays in the center of the second row of the screen.

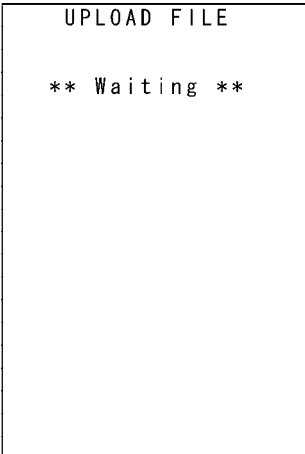

- 4. By executing the BHT-BASIC 4.0 Transfer Utility or similar program, the screen on the right displays and file uploading is commenced.

(Refer to the “BHT-BASIC4.0 Transfer Utility User’s Guide.”)

```
UPLOAD FILE  
  
** Loading **
```

- 5. The screen on the right displays during uploading.

The screen on the right displays indicating the file name and the number of sent records/the total number of records.

(When using the Ymodem protocol, the sent file size/the total file size (units: KB) displays.)

Press and hold the **BS/C** key to abort the download process and return to the UPLOAD menu.

```
UPLOAD FILE  
  
XXXXXXXXX.XXX  
** Loading **  
  
XXXXXXXXX/YYYYYYY
```

- 6. When uploading is complete, the beeper sounds once and the screen on the right displays.

When the number of sent records equals the total number of records, downloading is complete.

(When using the Ymodem protocol, the sent file size equals the total file size.)

Press and hold the **BS/C** key to return to the UPLOAD menu.

If “2: ALL FILES” or ”3: HT<-->HT COPY” is selected, repeat the above operation until all files are uploaded.

If an error message displays during uploading, refer to “Chapter 7 Error Messages”.

```
UPLOAD FILE  
  
XXXXXXXXX.XXX  
** Completed **
```

## 4.5.4 Copying Files between 2 BHT Units

Copy “all files (excluding font files)”, “setting data”, and the “date and time” stored in the BHT user area to another BHT.

Use the following procedure to copy files between 2 BHT units.

### 1. Set the same interface at both BHT units.

An infrared communication (Optical) interface and connector communication (Connector) interface are available.

The default interface is set to infrared communication (Optical).

#### Changing the Interface

Select “4: SET SYSTEM” → “5: COMMUNICATION” → “3: COM PORT” from the SYSTEM MENU, and change at the [2: SYSTEM MODE] “INTEFACE USED” item.

### 2. Set “COMMUNICATION PROTOCOL OPTION” → “FIELD SPACE” (space at the end of the field) to “Ignore” at both BHT units.

The default setting is “Ignore”.

Refer to “4.5.5 System Environment Settings (SET SYSTEM Menu)” when changing the interface.

### 3. When using infrared communication, ensure that the BHT infrared communication ports are facing one another.

- When using the connector interface, open the BHT connector covers and connect both BHT units using a cable with JC-25-P-3 (φ2.5mm stereo mini-plug).  
(Refer to “Chapter 8 Specifications” for cable details.)

### 4. Select “2: DOWNLOAD” → “2: HT<-->HT COPY” at the SYSTEM MENU of the BHT that is downloading to await downloading.

Refer to “4.5.2 Downloading Files (DOWNLOAD Menu)” for details.

When copying only the system parameter file, use the SYSTEM PARAMETER transfer menu. Refer to “4.5.12 Downloading/Uploading the BHT System Parameter File (SYSTEM PARAMETER Menu)” for details.

### 5. Select “3: UPLOAD” → “3: HT<-->HT COPY” at the SYSTEM MENU of the BHT that is uploading to await uploading.

Refer to the “4.5.3 Uploading Files (UPLOAD Menu)” for details.

When copying only the system parameter file, use the SYSTEM PARAMETER transfer menu. Refer to “4.5.12 Downloading/Uploading the BHT System Parameter File (SYSTEM PARAMETER Menu)” for details.

### 6. Preparation at both BHT units is now complete and file copying will be commenced.

---

- Note - The following setting data is copied when copying between BHT units.

---

LCD contrast level

Beeper volume

Switching between beeper and vibrator

Program to be executed automatically when the BHT is turned ON

Message version (English or Japanese)

---

Display font size

System status display

Date

Time

Setting of black-and-white inverted label reading function (enable/disable)

---

Decode level

Minimum number of digits to be read for ITF

Minimum number of digits to be read for STF

Minimum number of digits to be read for Codabar (NW-7)

Interface port to be used in user programs

---

Interface port to be used in System Mode

Communication parameters for the infrared interface

Communication parameters for the direct-connect interface

Communication protocol options for the infrared interface

Communication protocol options for the direct-connect interface

---

Communication protocol type

Shift key function definition

M1 key function definition

M2 key function definition

M3 key function definition

---

M4 key function definition

M5 key function definition

Resume function

Remote wake-up setting (enable/disable)

Transmission speed for remote wake-up

---

Remote wake-up history

BHT-5000 screen compatibility mode

YMODEM option

IP address of FTP server

User name of FTP server

---

Password of FTP server

Default directory for FTP server

FTP option, Line delimiters (CR/LF)

FTP option, Handling of line delimiters

FTP option, Handling of trailing spaces in data fields

---

---

FTP option, Upload mode  
 FTP option, Verbose mode  
 IP address of host computer for ping-test  
 Data size of echo request  
 Echo request intervals

---

Timeout period for echo request  
 No. of echo requests to be sent  
 Echo request send timing  
 TCP/IP operation device  
 TCP/IP link layer

---

Transmission speed between BHT and CU  
 No. of retries for link establishment command to be sent  
 Link establishment command intervals  
 No. of retries for link release command to be sent  
 Link release command intervals

---

Link release period  
 Service Set ID (SSID) (Not possible to copy correctly if there is a space at the end.)  
 Maximum DHCP IP address acquisition wait time

---

The following data is the setting data for the BHT-504BW only.

---

Power save mode for wireless module  
 Authentication system  
 WEP (Wired Equivalent Privacy) (enable/disable)  
 Wireless method  
 Wireless security mode

---

Wireless security EAP authentication method  
 Wireless security encryption method  
 Wireless security root certificate filename  
 Wireless security EAP start time  
 Wireless security retry interval for non-response

---

Wireless security retry interval for authentication failure  
 Wireless security retry interval for authentication start failure  
 Wireless security retry count for authentication start failure

---

## 4.5.5 System Environment Settings (SET SYSTEM Menu)

Use the following procedure to set the system environment.

1. Select "4: SET SYSTEM" at the SYSTEM MENU and then press the **ENT** key.

The SET SYSTEM menu screen on the right displays.

"1: EXECUTE PROGRAM":

Sets the auto-start execution program to be executed when the power is turned ON.

"2: DISPLAY":

Sets the message version (English or Japanese).

"3: DATE/TIME":

Sets the calendar clock (date and time).

"4: BARCODE":

Sets the barcode scanning conditions (black/white inverted label scanning function and decode label), minimum number of scan digits for scan codes (ITF, STF, Codabar) and the operation (scan mode, guide marker, power OFF time for the scanning area) for the scanning area.

"5: COMMUNICATION":

Sets the communication environment (interface port and communication parameters).

"6: KEY":

Defines the functions of the shift key and magic keys.

"7: RESUME":

Sets the resume function.

"8: DEFRAG":

Defragments the drive.

"9: TCP/IP":

Displays the setting menu for TCP/IP, FTP and DHCP.

Refer to the following section for details of the above items.

Press and hold the **BS/C** key to return to the SYSTEM MENU.

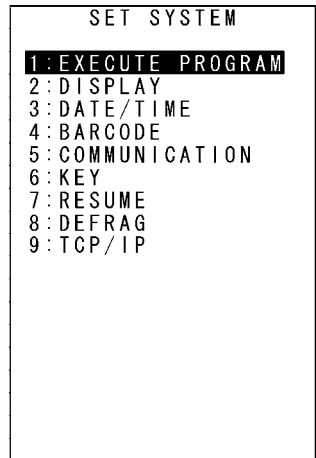

[1] Setting the auto-start execution program

Use the following procedure to set the auto-start execution program.

- 1. Select "1: EXECUTE PROGRAM" at the SET SYSTEM menu and then press the ENT key.

The SET EXECUTE PROGRAM menu screen on the right displays.  
 The highlighted program will be the program currently set as the auto-start execution program.

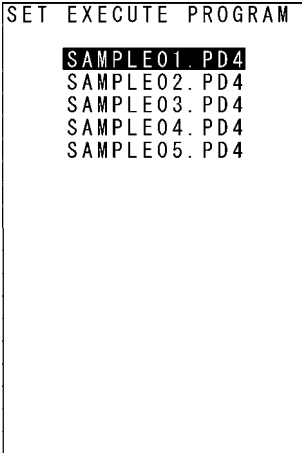

- 2. Use the cursor keys ([▲] [▼]) to highlight the target program.

- 3. Press the ENT key.

The selected program will be set as the auto-start execution program.

Press and hold the BS/C key to return to the SET SYSTEM menu.

The screen on the right displays if no programs have been downloaded.

Press and hold the BS/C key to return to the SET SYSTEM menu.

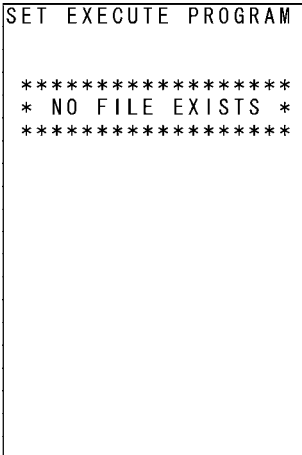



**[2] Setting the message version and system status indication**

Use the following procedure to set the display language and system status indication.

- 1.** Select "2: DISPLAY" at the SET SYSTEM menu and then press the **ENT** key.

The SET DISPLAY menu on the right displays.  
The highlighted settings will be the current settings.

- 2.** Use the cursor keys ([▲] [▼]) or numerical keys ([1] [2]) to highlight "1: MESSAGE" or "2: STATUS".

- 3.** Highlight the target setting with the cursor keys ([◀] [▶]) and press the **ENT** key.

Press and hold the **BS/C** key to return to the SET SYSTEM menu.

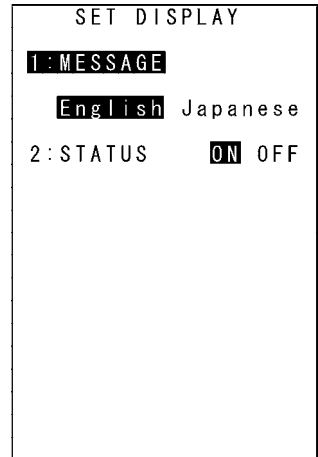

"1: MESSAGE":

Sets whether messages displayed at the screen are displayed in English or Japanese.  
The default is the message version selected at the system initializing process.  
The English and Japanese display changes at the following messages.

- System error messages
- Indications relating to the LCD contrast
- Beeper volume
- Beeper & vibrator switching
- Battery voltage level screens

"2: STATUS":

Sets whether to display or hide the system status displayed at the bottom of the screen.  
Refer to "System Status Indication" on the following page for details of the system status indication.

- "ON": The system status is displayed.
- "OFF": The system status is hidden.

---

- **Note** - The system status indication can be turned ON or OFF using the OUT statement in user programs. Refer to the "BHT-BASIC Programmer's Manual."

---

## ◆ System Status Indication

Turning ON the system status indication displays the following icons at the bottom of the screen.

| Indication                         | Icon | Description  |
|------------------------------------|------|--|
| Key Shift status                   |      | Displays when the keys on the keypad are in Shift mode.  |
| Alphabet entry mode                |      | Displays when the BHT is set to alphabet entry mode.<br>(If the alphanumeric entry system has been selected in user programs, pressing the <b>SF</b> key switches from the numeric entry mode to alphabet entry mode.)   |
| Communication link with the CU-511 |      | <p>Displays when a communication link is established with the CU-511.<br/>Flashes when the BHT tries to communicate with a CU-511 that has not been linked with the BHT.</p> <p>Displays cyclically when the BHT receives no response from the CU-511, or when it is waiting for the link to be established with or severed from the CU-511.</p>                                   |
| Radio link with access point *     |      | <p>If synchronization with the access point is established during wireless communication, the overall quality of communication with the access point is displayed incrementally. These respective icons indicate how good the communication environment is.</p> <p>Displays when synchronization with the access point has not been established, or when authentication fails.</p> |

\* BHT-504BW only

### [3] Setting the calendar clock

When resetting the date and time, refer to “Chapter 2 BHT Preparation” - “2.4 Initial Setup.”

Select “3: DATE/TIME” at the SET SYSTEM menu and press the **ENT** key to display the SET DATE/TIME menu screen on the right.

```

SET DATE/TIME

00/01/01 00:00
_ / /   :
    
```

**[4] Setting the special barcode scanning parameters**

Use the following procedure to set the barcode scanning conditions.

1. Select “4: BARCODE” at the SET SYSTEM menu and then press the **ENT** key.

The SET BARCODE menu screen on the right displays.  
The highlighted display and displayed values will be the current settings.

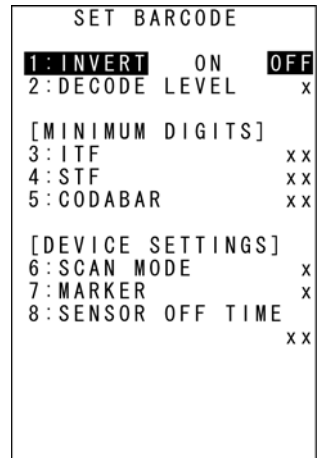

2. Use the cursor keys ([▲] [▼]) or numerical keys ([1] [2] [3] [4] [5] [6] [7] [8]) to highlight the item to be set.

3. Change settings with the cursor keys ([◀] [▶]) and press the **ENT** key.

Press and hold the **BS/C** key to return to the SET SYSTEM menu.

◆ **“1: INVERT”: Black/white inverted label scanning function**

Enable or disable black/white inverted label scanning.

- “ON”: Enables black/white inverted label scanning.
- “OFF”: Disables black/white inverted label scanning.

---

- Point - By enabling black/white inverted label scanning, it will also be possible to scan black/white inverted labels, however, there is higher chance of barcodes being incorrectly scanned. This should normally be set to “OFF” (black/white inverted label scanning disabled).

---

◆ **“2: DECODE LEVEL”: Decode level**

Set the decode level (barcode scanning tolerance level).  
Press [◀] to decrease the setting value and [▶] to increase the setting value.

Decode level entry range: 1 - 9 (Default: 4)

Decreasing the level increases the barcode reading efficiency, however, the BHT may incorrectly scan low-quality (split or stained) barcodes.

On the other hand, increasing the level decreases the barcode reading efficiency, but will decrease the possibility of incorrect scanning.

- ◆ **“3: ITF”**: Minimum number of digits to be read for ITF
- ◆ **“4: STF”**: Minimum number of digits to be read for STF
- ◆ **“5: CODABAR”**: Minimum number of digits to be read for Codabar

Set minimum number of digits for the code to be scanned.

Press [◀] to decrease the setting value and [▶] to increase the setting value.

|                      |        |              |
|----------------------|--------|--------------|
| ITF entry range:     | 2 - 20 | (Default: 4) |
| STF entry range:     | 1 - 20 | (Default: 3) |
| Codabar entry range: | 3 - 20 | (Default: 4) |

Setting a small number of digits increases the frequency of missing digits when scanning or incorrectly scanning depending on how barcodes are scanned or the quality of barcodes. On the other hand, setting a large number will decrease the possibility of such errors.

#### ◆ **“6: SCAN MODE”**

It is possible to perform scanning in normal mode or point scan mode.

0: Normal mode

Barcodes that lie within the size of the field of view can be scanned.

Refer to “Chapter 8 Specifications” for details of the field of view size.

1: Point scan mode

Only scan barcodes that lie on the guide marker line.

Scanning is not possible if there is no barcode on the guide marker.

Furthermore, in cases where the guide marker cannot be detected due to ambient light and so on, scanning is performed at roughly the center of the field of view.

#### ◆ **“7: MARKER”**: Guide Marker

It is possible to select whether to illuminate the guide marker when the trigger switch is pressed.

0: ON (Illuminates the guide marker.)

1: OFF (Does not illuminate the guide marker.)

#### ◆ **“8: SENSOR OFF TIME”**: Scanning area power OFF time

It is possible to set the time from when the trigger switch is turned OFF until the scanning area (sensor) power is turned OFF.

OFF time setting range: 0 – 30 seconds (Default: 0 seconds)

**[5] Setting the communication environment**

The communication environment settings following system initialization are follows.  
Do not change these settings unless necessary.

| Item                                       | Default  |
|--|--|
| Interface port                             | Optical (infrared interface port)  |
| Communication protocol                     | Ymodem protocol  |
| Infrared interface port                    |  |
| TRANSMIT SPEED      Baud rate              | 115200 bps   |
| PROTOCOL              Protocol options     | SERIAL No.:      ON (Adds serial numbers to data blocks.)<br>H. PARITY:        ON (Adds horizontal parity.)<br>LINKUP TIME:     30 seconds<br>FIELD SPACE:     Ignore (Trim) |
| Direct-connect interface port              |  |
| TRANSMIT SPEED      Baud rate              | 115200 bps   |
| PARITY BIT              (Vertical parity)  | None   |
| DATA BIT                (Character length) | 8 bits   |
| STOP BIT                (Stop bit length)  | 1 bit  |
| PROTOCOL              (Protocol options)   | SERIAL No.:      ON (Adds serial numbers to data blocks.)<br>H. PARITY:        ON (Adds horizontal parity.)<br>LINKUP TIME:     30 seconds<br>FIELD SPACE:     Ignore (Trim) |

Use the following procedure if necessary to change the communication environment settings.

1. Select "5: COMMUNICATION" at the SET SYSTEM menu and then press the **ENT** key.

The SET COMMUNICATION menu screen on the right displays.

```

SET COMMUNICATION
1: OPTICAL
2: CONNECTOR
3: COM PORT
4: PROTOCOL TYPE
  
```

2. Use the cursor keys ([▲] [▼]) or numerical keys ([1] [2] [3] [4]) to highlight the item to be set and press the **ENT** key.

"1: OPTICAL":

Changes the infrared communication parameters.

"2: CONNECTOR":

Changes the connector communication parameters.

"3: COM PORT":

Changes the communication port setting.

"4: PROTOCOL TYPE":

Changes the communication protocol setting.

Refer to the following section for details of the above items.

Press and hold the **BS/C** key to return to the SYSTEM MENU.

#### ◆ "1: OPTICAL": Infrared communication parameters

1. Select "1: OPTICAL" at the SET COMMUNICATION menu and then press the **ENT** key.

The SET OPTICAL menu screen on the right displays.

```

SET OPTICAL
1: PARAMETER
2: PROTOCOL
  
```

2. Use the cursor keys ([▲] [▼]) or numerical keys ([1] [2]) to highlight "1: PARAMETER" or "2: PROTOCOL", and then press the **ENT** key.

Press and hold the **BS/C** key to return to the SET SYSTEM menu.

#### "1: PARAMETER": Setting the communication parameters

Select "1: PARAMETER" to display the screen shown on the right.

The highlighted setting will be the current setting.

```

SET PARAMETER
< OPTICAL >
1: TRANSMIT SPEED:
   9600  19200
 38400  57600
115200  460800
  
```

"1: TRANSMIT SPEED": Setting the transmission speed

To change the setting, use the highlight the transmission speed with the cursor keys ([◀] [▶]) and press the **ENT** key.

Press and hold the **BS/C** key to return to the SET OPTICAL menu.

**“2: PROTOCOL”: Communication protocol options setting screen**

Select “2: PROTOCOL” to display the screen shown on the right

The highlighted settings will be the current settings.

**“1: SERIAL No.”:**

Selects whether or not to add serial numbers to data blocks.

**“2: H.PARITY”:**

Selects whether or not to add horizontal parity.

**“3: LINKUP TIME”:**

Selects the timeout length (in seconds) to be applied when a link is to be established.

**“4: FIELD SPACE”:**

Specifies handling for trailing spaces in fields.

To trim trailing spaces in fields, select “Ignore”, and to retain them as data, select “Data”.

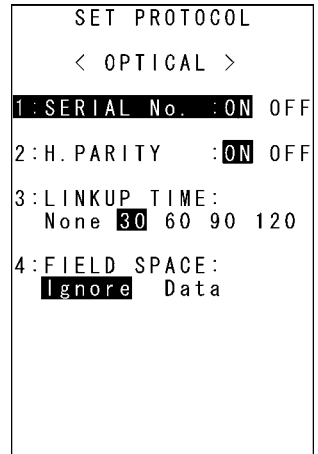

To make changes, use the cursor keys ([▲] [▼]) or numerical keys ([1] [2] [3] [4]) to highlight the item to be set, highlight the setting value using the cursor keys ([◀] [▶]), and then press the **ENT** key. Press and hold the **BS/C** key to return to the SET OPTICAL menu.

---

- Point - Selecting the BHT-Ir or YMODEM protocol ignores the serial number and horizontal parity settings.

---

◆ “2: CONNECTOR”: Connector communication environment settings

1. Select “2: CONNECTOR” at the SET COMMUNICATION menu and then press the **ENT** key.

The SET CONNECTOR menu screen on the right displays.

2. Use the cursor keys ([▲] [▼]) or numerical keys ([1] [2]) to highlight “1: PARAMETER” or “2: PROTOCOL”, and then press the **ENT** key.

Press and hold the **BS/C** key to return to the SET COMMUNICATION menu.

```

SET CONNECTOR
  1: PARAMETER
  2: PROTOCOL
  
```

“1: PARAMETER”: Setting the communication parameters

Select “1: PARAMETER” to display the screen shown on the right.

The highlighted settings will be the current settings.

- “1: TRANSMIT SPEED”: Sets the transmission speed.  
 “2: PARITY BIT”: Sets the vertical parity: none, odd, or even.  
 “3: DATA BIT”: Sets the character length.  
 “4: STOP BIT”: Sets the stop bit length.

To make changes, use the cursor keys ([▲] [▼]) or numerical keys ([1] [2] [3] [4]) to highlight the item to be set, highlight the setting value using the cursor keys ([◀] [▶]), and then press the **ENT** key.

Press and hold the **BS/C** key to return to the SET CONNECTOR menu.

```

SET PARAMETER
< CONNECTOR >
  1: TRANSMIT SPEED:
    300 600 1200 2400
    4800 9600 19200
    38400 57600 115200
  2: PARITY BIT: N E 0
  3: DATA BIT : 7 8
  4: STOP BIT : 1 2
  
```

- 
- Point -
- Selecting the BHT-lr protocol ignores the vertical parity, character length, and stop bit length settings.
  - Selecting YMODEM requires the vertical parity, character length, and stop bit length to be set to N, 8 and 1, respectively.
-



## “2: PROTOCOL”: Communication protocol option menu

Select “2: PROTOCOL” to display the screen shown on the right.

The highlighted settings will be the current settings.

### “1: SERIAL No.”:

Selects whether or not to add serial numbers to data blocks.

### “2: H.PARITY”:

Selects whether or not to add horizontal parity.

### “3: LINKUP TIME”:

Selects the timeout length (in seconds) to be applied when a link is to be established.

### “4: FIELD SPACE”:

Specifies the handling for trailing spaces in fields.

To trim trailing spaces in fields, select “Ignore”, and to retain them as data, select “Data”.

To make changes, use the cursor keys ([▲] [▼]) or numerical keys ([1] [2] [3] [4]) to highlight the item to be set, highlight the setting value using the cursor keys ([◀] [▶]), and then press the **ENT** key.

Press and hold the **BS/C** key to return to the SET CONNECTOR menu.

```
SET PROTOCOL
< CONNECTOR >
1: SERIAL No. :ON OFF
2: H. PARITY  :ON OFF
3: LINKUP TIME:
  None 30 60 90 120
4: FIELD SPACE:
  Ignore Data
```

---

- Point - Selecting the BHT-Ir or YMODEM protocol ignores the serial number and horizontal parity settings.

---

### ◆ “3: COM PORT”: Setting the interface port

1. Select “3: COM PORT” at the SET COMMUNICATION menu and then press the **ENT** key.

The SET COM DEFAULT PORT menu screen on the right displays.

The highlighted settings will be the current settings.

#### “1: BASIC”

Selects the infrared communication (Optical) or connector communication (Connector) interface port to be used for user programs written in BHT-BASIC (OPEN “COM:”).

“Optical”: Uses infrared communication.

“Connector”: Uses connector communication.

#### “2: SYSTEM MODE”

Selects the infrared communication (Optical) or connector communication (Connector) interface port to be used for downloading or uploading files in System Mode.

“Optical”: Uses infrared communication.

“Connector”: Uses connector communication.

To make changes, use the cursor keys ([▲] [▼]) or numerical keys ([1] [2]) to highlight the item to be set, highlight the setting value using the cursor keys ([◀] [▶]), and then press the **ENT** key.

Press and hold the **BS/C** key to return to the SET COMMUNICATION menu.

```

SET COM DEFAULT PORT
1: BASIC
   Optical Connector
2: SYSTEM MODE
   Optical Connector
  
```

## ◆ “4: PROTOCOL TYPE”: Setting the communication protocol type

1. Select “4: PROTOCOL TYPE” at the SET COMMUNICATION menu and then press the **ENT** key.

The PROTOCOL TYPE menu screen on the right displays.  
The highlighted setting will be the current setting.

“1: Ymodem”:

Selects Ymodem when uploading/downloading in System Mode or for the execution of the XFILE statement in BHT-BASIC.

“2: BHT Protocol”:

Selects the BHT-protocol when uploading/downloading in System Mode or for the execution of the XFILE statement in BHT-BASIC.

“3: BHT-Ir Protocol”:

Selects the BHT-Ir protocol when uploading/downloading in System Mode or for the execution of the XFILE statement in BHT-BASIC.

To make changes, use the cursor keys ([▲] [▼]) or numerical keys ([1] [2] [3]) to highlight the setting item, and then press the **ENT** key.

To use the BHT-BASIC 4.0 Transfer Utility, select Ymodem or BHT-Ir protocol.  
Press and hold the **BS/C** key to return to the SET COMMUNICATION menu.

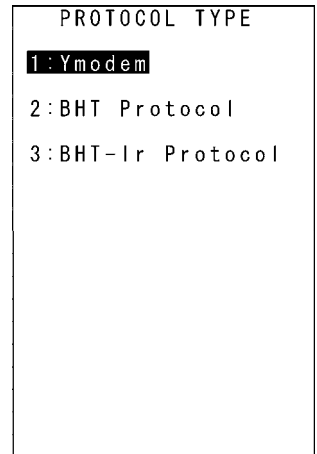

Select “1: Ymodem” at the PROTOCOL TYPE menu to display the screen on the right.

The highlighted settings will be the current settings.

“1: CR/LF”:

Specifies line delimiters.

“2: CR/LF CODE”:

Specifies handling for line delimiters in records when data files are downloaded.

“Control code”:

Does not handle line-break codes as data.

(Handles as record delimiters.)

“Data”:

Handles line-break codes as data.

“3: BHT ID”:

Specifies whether or not to add the BHT ID number to packets when performing YMODEM transfer.

“None” should normally be selected. To add the BHT ID number to the transfer tool, select “Add”. (This setting is not supported. Changing this setting has no result.)

“4: INTERVAL”:

Specifies the retry interval within a range of 1 to 255 in units of 100 ms.

To make changes, use the cursor keys ([▲] [▼]) or numerical keys ([1] [2] [3] [4]) to highlight the item to be set, highlight the setting value using the cursor keys ([◀] [▶]), and then press the **ENT** key.

For “4: INTERVAL”, press the **ENT** key to change to entry mode.

The cursor displays, allowing the previous setting to be deleted by pressing the **BS/C** key.

Enter a new setting values with the numerical keys and press the **ENT** key.

Press and hold the **BS/C** key to return to the SET COMMUNICATION menu.

```

SET YMODEM
1: CR/LF
   CR-LF LF CR None
2: CR/LF CODE
   Control code Data
3: BHT ID
   None Add
4: INTERVAL [ ]

```

Select "3: BHT-Ir Protocol" at the PROTOCOL TYPE menu to display the screen on the right.

Enter the ID number of the BHT using the numerical keys and then press the **ENT** key. If there is no need to edit the current setting, press the **ENT** key only.

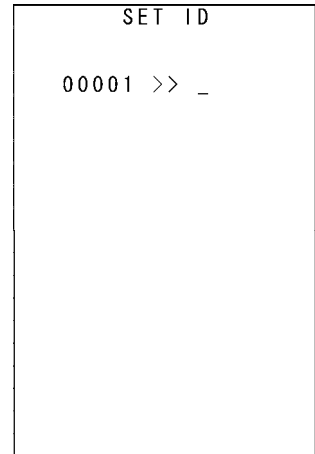

---

- Point - ID numbers should consist of a five-digit decimal character string. The entry range is from 00001 to 65534. If the entry value is less than five digits, the **ENT** key will be invalid.

---

If an incorrect entry is made, press the **BS/C** key to delete it and then enter the correct data.

Press and hold the **BS/C** key to return to the SET COMMUNICATION menu.

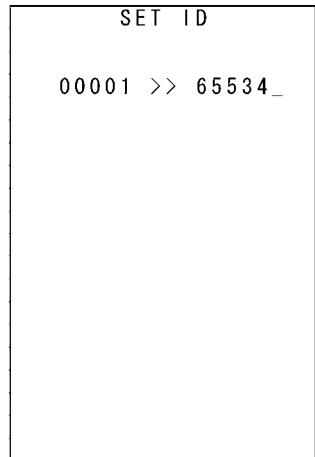

## [6] Defining the functions of the Shift key and Magic keys

Use the following procedure to change the key settings.

1. Select "6: KEY" at the SET SYSTEM menu and then press the **ENT** key.

The SET KEY menu screen on the right displays.

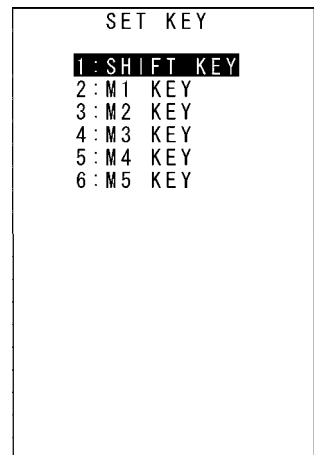

2. Use the cursor keys ([▲] [▼]) or numerical keys ([1] [2] [3] [4] [5] [6] [7]) to highlight the item to be set, and then press the **ENT** key.

- "1: SHIFT KEY": Displays the **SF** key definition screen.
- "2: M1 KEY": Displays the **M1** key definition screen.
- "3: M2 KEY": Displays the **M2** key definition screen.
- "4: M3 KEY": Displays the **M3** (left-hand trigger switch) key definition screen.
- "5: M4 KEY": Displays the **M4** (right-hand trigger switch) key definition screen.
- "6: M5 KEY": Displays the **M5** key ([MENU] key) definition screen.

Refer to the following section for details of the above items.

Press and hold the **BS/C** key to return to the SET COMMUNICATION menu.

### ◆ "1:SHIFT KEY": Defining the Shift key function

1. Select "1: SHIFT KEY" at the SET KEY menu and then press the **ENT** key.

The SET SHIFT KEY menu screen on the right displays.

The highlighted setting will be the current setting.

- "1: Nonlock": Shifts the keypad only when the **SF** key is held down.
- "2: Onetime": Shifts only the key pressed immediately after the **SF** key is pressed. (The following keys will not be shifted.)

2. Use the cursor keys ([▲] [▼]) or numerical keys ([1] [2]) to highlight the item to be set, and then press the **ENT** key.

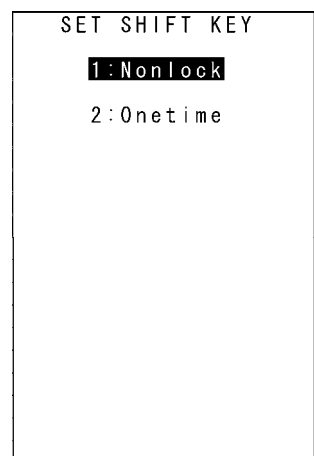

The selected item will be set and the screen will return to the SET KEY menu.

◆ “2: M1 KEY” - “6: M5 KEY”: Defining the Mx key functions

1. Select “2: M1 KEY” to “6: M5 KEY” at the SET KEY menu and then press the **ENT** key.

The SET Mx KEY menu screen on the right displays.  
 (In the example on the right, “2: M1 KEY” has been selected.)  
 The highlighted setting will be the current setting.



- “1: None”:  
Key entry will be ignored.
- “2: Trigger Switch”:  
Sets the magic key as the trigger switch.
- “3: Shift Key”:  
Sets the magic key as the **SF** key.
- “4: Enter Key”:  
Sets the magic key as the **ENT** key.
- “5: Backlight Key”:  
Sets the magic key as the backlight function ON/OFF key.
- “6: MENU”:  
Sets the magic key as a key used to start up the “Beeper/Vibrator/Backlight Adjustment Screen”.

2. Use the cursor keys ([▲] [▼]) or numerical keys ([1] [2] [3] [4] [5] [6]) to highlight the item to be set, and then press the **ENT** key.

The selected item will be set and the screen will return to the SET KEY menu.

◆ Magic keys (M1 to M5)

Magic keys (**M1** to **M5**) can be set to function as the trigger switch, **SF** key, **ENT** key, or backlight function ON/OFF key.

If the **M1** key is defined as the backlight function ON/OFF key, pressing the **M1** key enables or disables the backlight function.

In user programs, data strings can be also assigned to these magic keys.

Magic keys **M3** and **M4** are set as the trigger switch by default.

---

- Point - The backlight function ON/OFF key can be assigned only to one of the magic keys from **M1** to **M4**. The key defined more recently will act as the backlight function ON/OFF key and the previously defined key will be ignored.

If, for example, the **M1** and **M2** keys are defined as the backlight function ON/OFF key in this order, the **M2** key will function as the backlight function ON/OFF key and the **M1** key entry will be ignored.

On the other hand, if the **M2** and **M1** keys are defined as the backlight function ON/OFF key in this order, the **M1** key will function as the backlight function ON/OFF key and the **M2** key entry will be ignored.

---

**[7] Setting the resume function**

Use the following procedure to set the resume function.

1. Select "7: RESUME" at the SET SYSTEM menu and then press the **ENT** key.

The SET RESUME menu screen on the right displays.  
The highlighted setting will be the current setting.

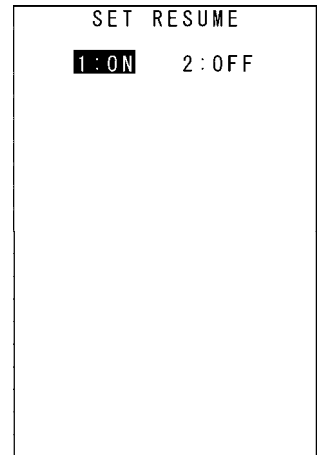

2. Use the cursor keys ([▲] [▼]) or numerical keys ([1] [2]) to change the setting and press the **ENT** key.

Press and hold the **BS/C** key to return to the SET SYSTEM menu.

"1: ON": Enables the resume function.  
"2: OFF": Disables the resume function.

---

**- Note -** The resume function is used to return the BHT status (screen) when the power is turned ON to the status at the point the power was turned OFF.

---

**[8] Defragmenting the drive**

Use the following procedure to defragment the drive.

1. Select "8: DEFRAG" at the SET SYSTEM menu and then press the **ENT** key.

The screen on the right displays and the defragmentation process is performed for the entire user area.  
The screen returns to the SYSTEM MENU when defragmentation is complete.

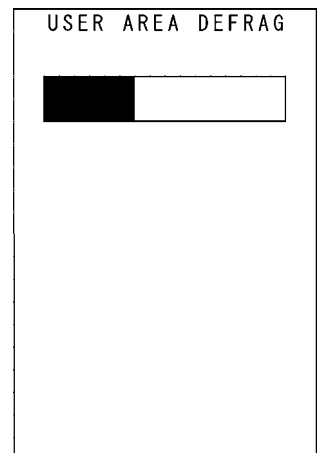

Defragmentation reorganizes the user area in order to increase the amount of available space.

If defragmented, the BHT may download files more efficiently than before performing defragmentation.



**[9] Setting the TCP/IP, FTP and DHCP**

Use the following procedure to change the TCP/IP, FTP and DHCP settings.

1. Select "9: TCP/IP" at the SET SYSTEM menu and then press the **ENT** key.

The SET TCP/IP menu screen on the right displays.

2. Use the cursor keys ([▲] [▼]) or numerical keys ([1] [2] [3]) to highlight the item to be set, and then press the **ENT** key.

- "1: SET TCP/IP": Changes the TCP/IP setting.
- "2: SET FTP": Changes the FTP setting.
- "3: SET DHCP": Changes the DHCP setting.

Refer to the following section for details of the above items.  
Press and hold the **BS/C** key to return to the SET SYSTEM menu.

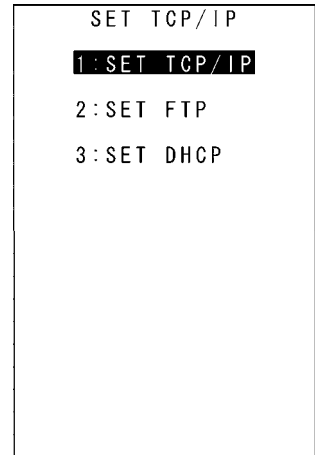

◆ **"1: SET TCP/IP": Setting the TCP/IP**

1. Select "1: SET TCP/IP" at the SET TCP/IP menu and then press the **ENT** key.

The SET TCP/IP menu screen on the right displays.

2. Use the cursor keys ([▲] [▼]) or numerical keys ([1] [2]) to highlight the item to be set, and then press the **ENT** key.

Press and hold the **BS/C** key to return to the SET TCP/IP menu.

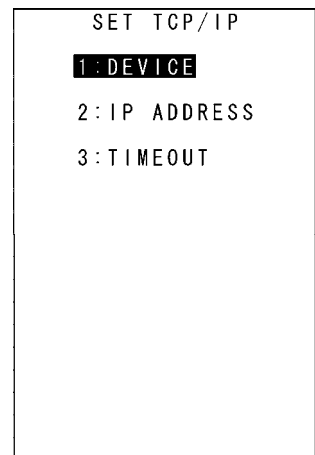

**"1: DEVICE": Setting the TCP/IP device**

Select "1: DEVICE" at the SET TCP/IP menu to display the screen on the right where the current settings are displayed.

- "1: TCP/IP DEVICE": TCP/IP communication device
- "2: LINK LAYER": Link layer
- "3: TRANSMIT SPEED": Transmission speed  
(when equipped with software supporting LAN communication)

Press and hold the **BS/C** key to return to the SET TCP/IP menu.

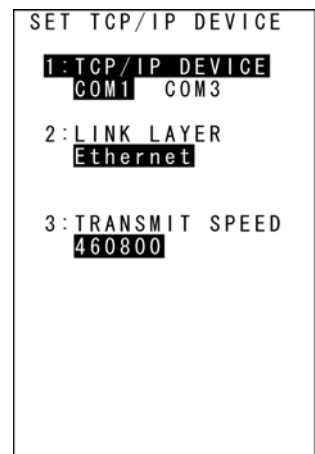

**“2: IP ADDRESS”: Setting the IP address**

Select “2: IP ADDRESS” at the SET TCP/IP menu to display the screen on the right where the current settings are displayed.

To change the setting:

- (1) Use the cursor keys ([▲] [▼]) or numerical keys ([1] [2] [3]) to highlight the item to be set and press the **ENT** key.
- (2) The mode changes to entry mode and the cursor displays, allowing the setting to be entered with the numerical keys and dot key.  
To delete a single character, press the **BS/C** key. To delete the entire entry, press and hold the **BS/C** key.
- (3) Enter the desired value and then press the **ENT** key.

```

SET ADDRESS
1: IP ADDRESS
  [XXX.XXX.XXX.XXX ]
2: SUBNET MASK
  [YYY.YYY.YYY.YYY ]
3: DEFAULT GATEWAY
  [ZZZ.ZZZ.ZZZ.ZZZ ]

```

If the IP address, subnet mask and default gateway are all set to [0.0.0.0], DHCP is enabled. Press and hold the **BS/C** key to return to the SET TCP/IP menu.

**“3: TIMEOUT”: Setting the timeout (when equipped with software supporting LAN communication)**

Select “3: TIMEOUT” at the SET TCP/IP menu to display the screen on the right where the current settings are displayed.

Use the cursor keys ([▲] [▼]) to switch between the <CONNECTION> screen and <DISCONNECTION> screen.

To change the setting:

- (1) Use the cursor keys ([▲] [▼]) or numerical keys ([1] [2] [3] [4] [5]) to highlight the item to be set and press the **ENT** key.
- (2) The mode changes to entry mode and the cursor displays, allowing the setting to be entered with the numerical keys and dot key.  
To delete a single character, press the **BS/C** key. To delete the entire entry, press and hold the **BS/C** key.
- (3) Enter the desired value, and then press the **ENT** key.

Press and hold the **BS/C** key to return to the SET TCP/IP menu.

```

SET TIMEOUT 1/2
< CONNECTION >
1: RETRY COUNT
  [nnnnn]
2: RETRY INTERVAL
  [nnnnn]

```

[▲] key / [▼] key

```

SET TIMEOUT 2/2
< DISCONNECTION >
3: RETRY COUNT
  [nnnnn]
4: RETRY INTERVAL
  [nnnnn]
5: TIMEOUT [nnnnn]

```

◆ **Setting the FTP**

1. Select “2: SET FTP” at the SET TCP/IP menu and then press the **ENT** key.

The SET FTP menu screen on the right displays.

2. Use the cursor keys ([▲] [▼]) or numerical keys ([1] [2]) to highlight the item to be set, and then press the **ENT** key.

Press and hold the **BS/C** key to return to the SET TCP/IP menu.

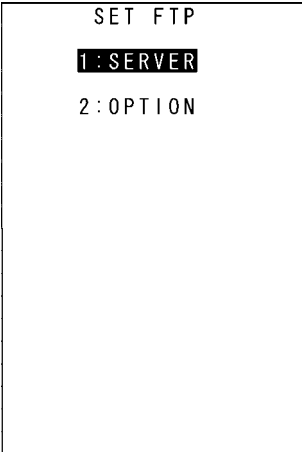

**“1: SERVER”: Setting the FTP server connection environment**

Select “1: SERVER” at the SET FTP menu to display the screen on the right where the current settings are displayed.

Use the cursor keys ([▲] [▼]) to switch between screen 1/2 and 2/2.

“1: SERVER IP”:

Sets the IP address for the FTP server.

“2: USER ID”:

Sets the user name.

“3: PASSWORD”:

Sets the password.

“4: DEFAULT DIR”:

Specifies an initial directory through which the FTP server will search for files for transfer first when the FTP client establishes a connection to the server.

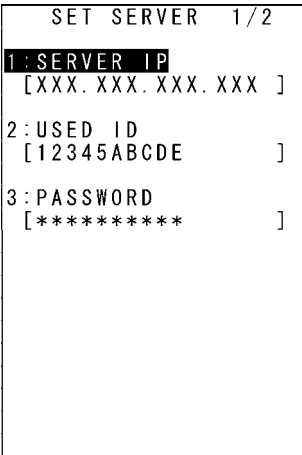

[▲] key / [▼] key

To change the setting:

- (1) Use the cursor keys ([▲] [▼]) or numerical keys ([1] [2] [3] [4]) to highlight the item to be set and press the **ENT** key.
- (2) The mode changes to entry mode and the cursor displays, allowing the setting to be entered with the numerical keys and dot key.  
Press the **SF** key to change the entry mode (numeric entry (with no guidance display) and alphabet entry).  
To delete a single character, press the **BS/C** key. To delete the entire entry, press and hold the **BS/C** key.
- (3) Enter the desired value, and then press the **ENT** key.

Press and hold the **BS/C** key to return to the SET FTP menu.

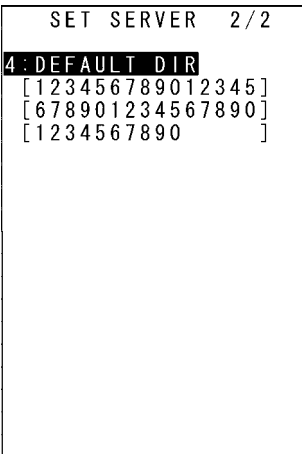

**“2: OPTION”: Setting the FTP options**

Select “2: OPTION” at the SET FTP menu to display the screen on the right where the current settings are displayed.

Use the cursor keys ([▲] [▼]) to switch between screen 1/2 and 2/2.

**“1: CR/LF”:**

Specifies line delimiters that should match ones used in the server OS.

**“2: CR/LF CODE”:**

Specifies the treatment of line delimiters in records when data files are downloaded.

“Control code”: Does not handle line-break codes as data.  
(Handles as record delimiters.)

“Data”: Handles line-break codes as data.

**“3: FIELD SPACE”:**

Specifies the treatment of trailing spaces in fields.

“Ignore”: Trims trailing spaces in fields.

“Data”: Retains trailing spaces as data.

**“4: UPLOAD MODE”:**

Specifies handling for trailing spaces in fields.

“Overwrite”: Uploaded files will be written over the existing files

“Append”: Uploaded files will be appended to the existing files.

**“5: VERBOSE MODE”:**

Specifies the command response display when using FTP.

“ON”: Displays a message to the response (number) from the FTP server when the BHT (FTP client) outputs a message.

“OFF”: Displays only messages output by the BHT (FTP client).

```

SET OPTION 1/2
1: CR/LF
   CR-LF LF CR None
2: CR/LF CODE
   Control code Data
3: FIELD SPACE
   Ignore Data Intact

```

[▲] key / [▼] key

```

SET OPTION 2/2
4: UPLOAD MODE
   Overwrite Append
5: VERBOSE MODE
   ON OFF

```

Refer to “FTP Download/Upload Messages” at section “4.5.8 Downloading/Uploading Files by FTP (FTP MENU)” for messages output by the BHT (FTP client).

Refer to “Response Messages from the FTP Server” at section “4.5.8 Downloading/Uploading Files by FTP (FTP MENU)” for messages to responses (numbers) from the FTP server.

To change the setting:

- (1) Use the cursor keys ([▲] [▼]) or numerical keys ([1] [2] [3] [4] [5]) to highlight the item to be set and press the **ENT** key.
- (2) Use the cursor keys ([◀] [▶]) to highlight each setting value.
- (3) Press the **ENT** key.

Press and hold the **BS/C** key to return to the SET FTP menu.

◆ **Setting the DHCP**

1. Select "3: SET DHCP" at the SET TCP/IP menu and then press the **ENT** key.

The SET DHCP screen on the right displays.  
 The highlighted setting will be the current setting.  
 Press and hold the **BS/C** key to return to the SET TCP/IP menu.

Press the dot key while holding down the **SF** key at the SET DHCP menu to display the NETWORK (DHCP) screen (acquisition check screen for IP address at DHCP).  
 Press and hold the **BS/C** key at the NETWORK (DHCP) screen to return to the SET DHCP screen.

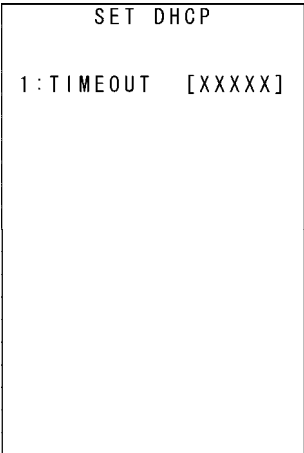

- Point - If the acquired IP configuration is displayed when the IP address, subnet mask or default gateway is set to a value other than "0.0.0.0", the DHCP does not display on the screen shown on the right.

**BS/C** key / **SF** key + [.] key

"1: TIMEOUT":  
 Sets the timeout for acquiring the IP configuration from the DHCP server. The entry range is from 00001 to 32767 seconds.

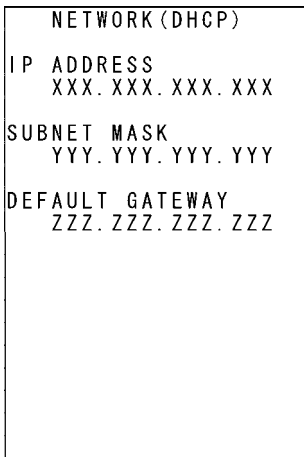

- Point - Up to 32767 seconds can be entered, but in actual operation, a maximum of 190 seconds is available since the number of retries and retry intervals are determined by the system.

To set the DHCP:

- (1) Press the **ENT** key.
- (2) The mode changes to entry mode and the cursor displays, allowing the setting to be entered with the numerical keys.  
 To delete a single character, press the **BS/C** key. To delete the entire entry, press and hold the **BS/C** key.
- (3) Enter the desired value, and then press the **ENT** key.

Press and hold the **BS/C** key to return to the SET FTP menu.

## 4.5.6 BHT Operation Test (TEST Menu)

Use the following procedure to perform a BHT operation test.

1. Select "5: TEST" at the SYSTEM MENU and then press the **ENT** key.

The TEST menu screen on the right displays.

"1: BARCODE":

Selects the barcode scanning test.

"2: MEMORY":

Selects the RAM read/write test.

"3: BEEPER":

Selects the beeper scale test.

"4: AGING":

Selects the aging test.

"5: LCD":

Selects the LCD and indicator LED tests.

"6: FILE":

Selects the file checksum test.

"7: COMMUNICATION":

Selects the communication test.

"8: KEY & VIBRATION":

Selects the key entry, beeper and vibrator tests.

"9: PING":

Selects the PING test.

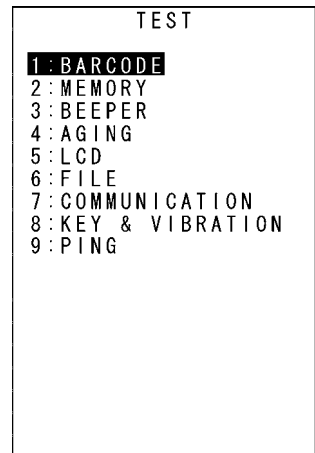

Refer to the following section for details of the above items.

Press and hold the **BS/C** key to return to the SYSTEM MENU.

---

- Point - Contact your nearest dealer if an error occurs during any of the above tests.

---

[1] **Barcode scanning test**

Use the following procedure to perform a barcode scanning test.

1. Select "1: BARCODE" at the TEST menu and then press the **ENT** key.

The screen on the right displays.

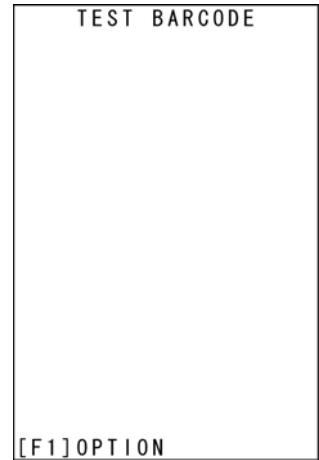

2. Scan a barcode with the BHT

Upon completion of barcode scanning, the BHT beeps once, and the indicator LED turns blue.

3. The scanned barcode type, number of digits, and data display at the barcode data and screen display match.

Press and hold the **BS/C** key to return to the TEST menu.

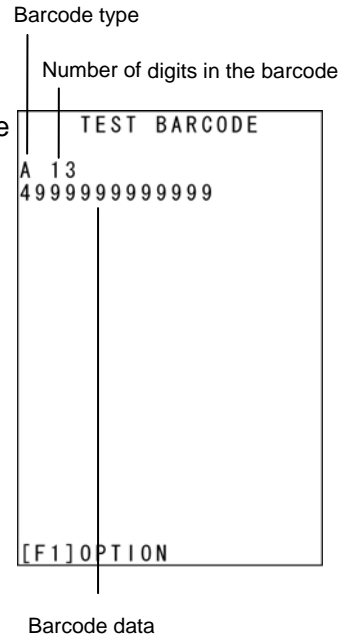

Barcode Type and Corresponding Characters Displayed on the Screen

| Barcode Type             | ID Characters |
|--------------------------|---------------|
| EAN-13, UPC-A            | A             |
| EAN-8                    | B             |
| UPC-E                    | C             |
| Standard 2of5 (STF)      | H             |
| Interleaved 2of5 (ITF) * | I             |
| Codabar (NW-7)           | N             |
| Code 39                  | M             |
| Code 93                  | L             |
| Code 128                 | K             |
| EAN-128                  | W             |
| RSS                      | R             |

\* With ITF, a barcode with 4 or more digits is scanned.

### ◆ Setting the Barcode Scanning Test Options

When performing the barcode scanning test, press the **F1** key to display the screen on the right, allowing barcode scanning test options to be set.

Details of option settings are as follows.

- [1] COMPOSITE: ON/OFF
- [2] Add-ON: ON/OFF
- [3] Multi-line: ON/OFF

- \* Multi-line scanning can be performed up to 2 lines, with 9 different types of code supported (Universal product codes (3 types), ITF, Codabar, Code39, Code93, Code128, STF)

```

TEST BARCODE
[OPTION]
1: COMPOSITE ON OFF
2: Add-on ON OFF
3: MultiLine ON OFF

[F1] RETURN
  
```

The highlighted settings will be the current settings.

“1: COMPOSITE”: Enables/disables composite code scanning.

“2: Add-on” : Enables/disables add-ons.

“3: MultiLine”: Enables/disables multi-line code scanning.

#### [1] Enabling/disabling composite code scanning

To change this setting, use the cursor keys ([▲] [▼]) [◀] [▶]) to highlight the setting value for each item. Press the **F1** key or **ENT** key to return to the barcode scanning test.

#### [2] Enabling/disabling add-ons

To change this setting, use the cursor keys ([▲] [▼]) [◀] [▶]) to highlight the setting value for each item. It is not possible to enable both add-ons and multi-line code scanning. Press the **F1** key or **ENT** key to return to the barcode scanning test.

#### [3] Enabling/disabling multi-line code scanning

When multi-line code scanning is enabled, the screen on the right displays, allowing a multi-line code with 2 lines to be set.

1ST: Set the scan code for the first line.

2ND: Set the scan code for the second line.

To change this setting, use the cursor keys ([▲] [▼]) [◀] [▶]) to highlight the setting value for each item.

Press the **F1** key or **ENT** key to return to the barcode scanning test.

```

TEST BARCODE
[OPTION]
1: COMPOSITE ON OFF
2: Add-on ON OFF
3: MultiLine ON OFF
1ST: EAN-13, UPC-A
2ND: EAN-13, UPC-A
  
```



## [2] Memory test

Use the following procedure to perform a memory test.

1. Select "2: MEMORY" at the TEST menu and then press the **ENT** key.

The screen on the right displays, and the BHT reads and writes data to and from all areas of the RAM and performs an address check.

"XXXXX": Tested RAM capacity (unit: kilobytes)

"YYYYY": Total RAM capacity (unit: kilobytes)

```
TEST MEMORY

** Testing **
XXXXX/YYYYY
```

If any error is detected, the BHT beeps three times, displays a message similar to that shown on the right, and aborts the test.

"ZZZZZZZZ": Address where the error occurred

"AAAAAAAA": Data to write

"BBBBBBBB": Data read out the RAM

Press and hold the **BS/C** key to return to the TEST menu.

```
TEST MEMORY

** Test NG **
XXXXX/YYYYY
Address : ZZZZZZZZ
Write   : AAAAAAAAAA
Read    : BBBBBBBBB
```

Upon normal completion of the RAM test, the BHT beeps once, displays a message similar to that shown on the right, and returns to the TEST menu.

```
TEST MEMORY

** Test OK **
YYYYY/YYYYY
```

**[3] Beeper scale test**

Use the following procedure to perform a beeper scale test.

1. Select "3: BEEPER" at the TEST menu and then press the ENT key.

The screen on the right displays, and the beeper sounds at the three octaves listed below.

Upon completion of this test, the BHT automatically returns to the TEST menu.

To stop the beeper scale test while in progress, turn the BHT OFF.

| Scale | Frequency (Hz) |      |      |      |
|-------|----------------|------|------|------|
| do    | 523            | 1046 | 2093 | 4186 |
| re    | 587            | 1174 | 2349 | –    |
| mi    | 659            | 1318 | 2637 | –    |
| fa    | 698            | 1396 | 2793 | –    |
| sol   | 783            | 1567 | 3135 | –    |
| la    | 880            | 1760 | 3520 | –    |
| ti    | 987            | 1975 | 3951 | –    |

TEST BEEPER

**[4] Aging test**

Use the following procedure to perform an aging test.

1. Select "4: AGING" at the TEST menu and then press the ENT key.

The aging test begins and the current date and time display on the screen. (This test is intended for personnel responsible for checking the BHT at the factory.)

---

- Point - The Auto OFF function is disabled during the aging test. To abort the test, press and hold the **BS/C** key to return to the TEST menu, or turn the BHT power OFF.

---

TEST AGING

DATE 05/08/01  
TIME 15:30:00

## [5] LCD and indicator LED tests

Use the following procedure to perform an LCD and indicator LED test.

### 1. Select "5: LCD" at the TEST menu and then press the **ENT** key.

The TEST BEEPER screen on the right displays.

The indicator LED is OFF at this time.

Press and hold the **BS/C** key to return to the TEST menu.



### 2. Press the **ENT** key.

The entire screen turns black.

Press the **BS/C** key to return to the previous screen.

Press and hold the **BS/C** key to return to the TEST menu.



### 3. Press the **ENT** key.

The entire screen turns gray.

Press the **BS/C** key to return to the previous screen.

Press and hold the **BS/C** key to return to the TEST menu.

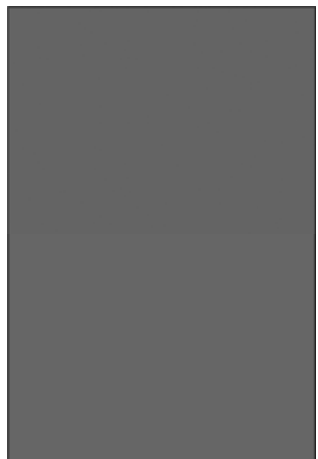

## 4. Press the **ENT** key.

The entire screen turns a lighter shade of gray.

Press the **BS/C** key to return to the previous screen.  
Press and hold the **BS/C** key to return to the TEST menu.

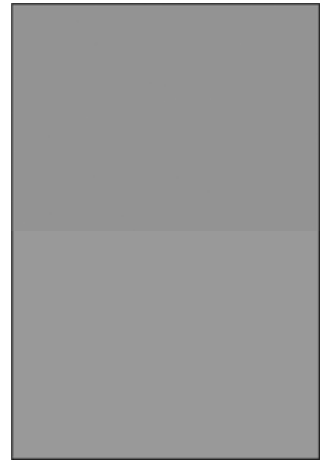

## 5. Press the **ENT** key.

The entire screen turns an even lighter shade of gray.

Press the **BS/C** key to return to the previous screen.  
Press and hold the **BS/C** key to return to the TEST menu.

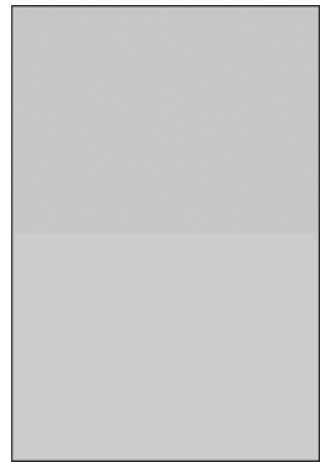

## 6. Press the **ENT** key.

The entire screen turns white.

Press the **BS/C** key to return to the previous screen.  
Press and hold the **BS/C** key to return to the TEST menu.

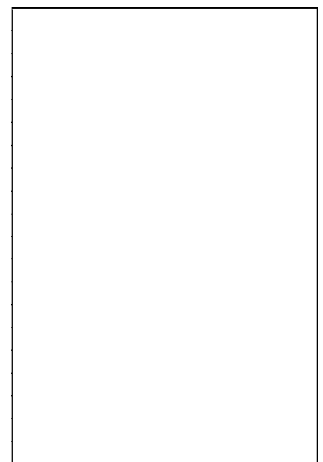

## 7. Press the **ENT** key.

The entire screen turns red, and at the same time, the indicator LED turns red.

Press the **BS/C** key to return to the previous screen.  
Press and hold the **BS/C** key to return to the TEST menu.

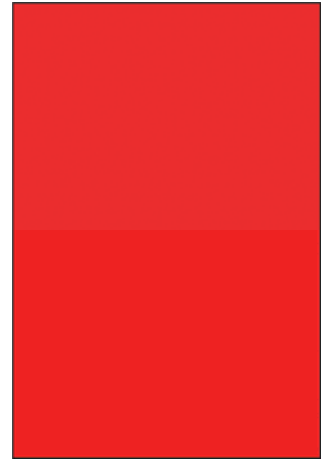

## 8. Press the **ENT** key.

The entire screen turns green, and at the same time, the indicator LED turns green.

Press the **BS/C** key to return to the previous screen.  
Press and hold the **BS/C** key to return to the TEST menu.

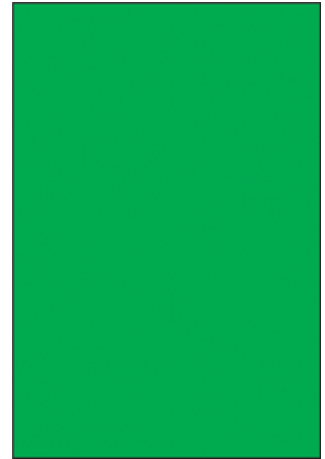

## 9. Press the **ENT** key.

The entire screen turns blue, and at the same time, the indicator LED turns blue.

Press the **BS/C** key to return to the previous screen.  
Press and hold the **BS/C** key to return to the TEST menu.

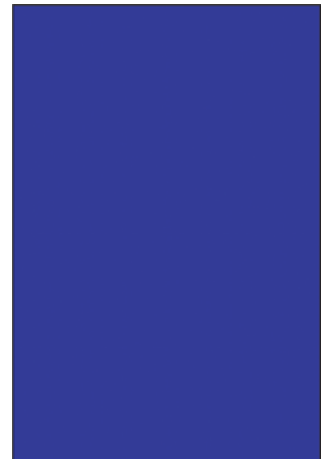

## 10. Press the **ENT** key.

A 1-dot thick frame displays around the screen.

Press the **BS/C** key to return to the previous screen.

Press and hold the **BS/C** key to return to the TEST menu.

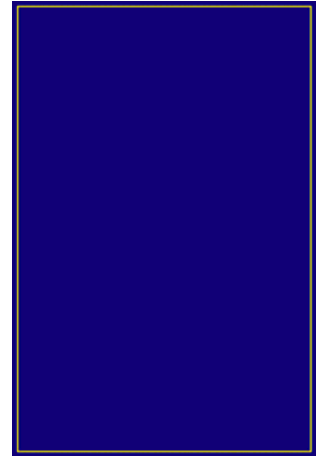

## 11. Press the **ENT** key.

The beeper sounds once, and the display returns to the TEST menu.

[6] File test

Use the following procedure to perform a file test.

1. Select "6: FILE" at the TEST menu and then press the **ENT** key.

The screen on the right displays, and if any of the files stored in the memory is defective, an asterisk (\*) or plus sign (+) is prefixed to the name of the defective file (s).

Refer to "Chapter 2 BHT Preparation" - "2.5.4 If the BHT Is Shut Down Abnormally" for details about the (\*) and (+).

"SIZE: bbbbb": Used memory size  
 "FREE: yyyyy": Available memory size

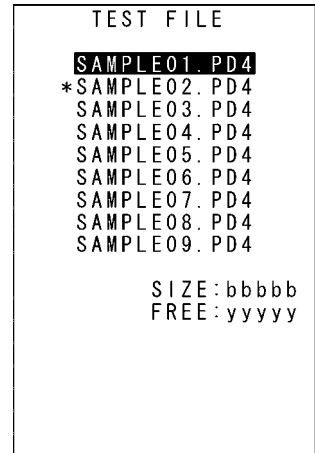

2. Use the cursor keys ([▲] [▼]) to highlight a file.

If there are more than ten files, the screen can be scrolled.

3. Press the **ENT** key.

The file name, file size, and test result (OK or NG) display as shown on the right.

**File Test Result**

"OK": No abnormalities  
 "NG": Abnormalities exist

Press and hold the **BS/C** key to return to the TEST menu.



- 
- Point -
- If a defective file is found, delete it or overwrite it with a file with the same name.
  - Even defective files can be uploaded at the UPLOAD menu. It is therefore recommended that important files be uploaded before being deleted.
- 



**[7] Communication test**

Use the following procedure to perform a communication test.

1. Select "7: COMMUNICATION" at the TEST menu and then press the **ENT** key.

The TEST BEEPER screen shown on the right displays.

"1: OPTICAL": Performs an infrared communication test.

"2: CONNECTOR": Performs a connector communication test.

Refer to the following section for details of the above items.

Press and hold the **BS/C** key to return to the TEST menu.

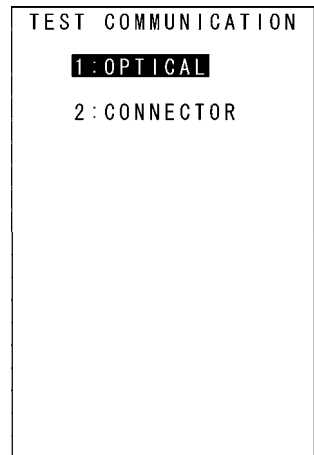

### ◆ Infrared Communication Test

1. Arrange two BHTs, one as a master station and the other as a slave station (to be tested) with their IrDA interface ports facing each other as illustrated below.

This test involves transmitting data from the test BHT and the master BHT returning the data to the test BHT.

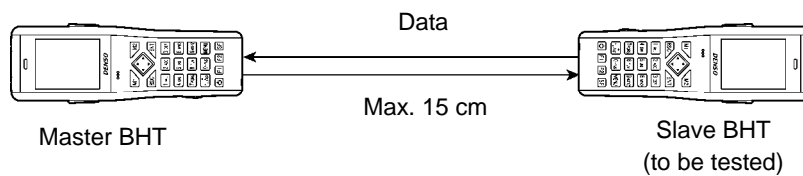

2. Select "1: OPTICAL" at the TEST COMMUNICATION menu and then press the **ENT** key.

The TEST COMMUNICATION screen displays as shown on the right.

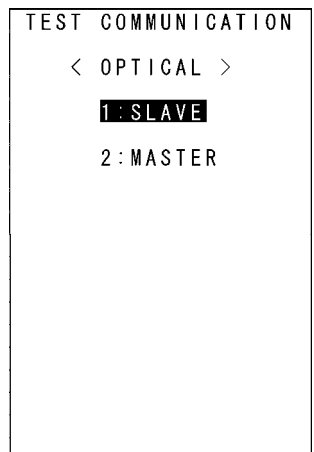



3. At the slave BHT to be tested, select “1: SLAVE”, and at the master BHT, select “2: MASTER”. Then press the **ENT** key.

The screen on the right displays during the test, and an infrared communication test is performed.

```

TEST COMMUNICATION
< OPTICAL >
** Testing **
    
```

If an error occurs, the tested slave BHT beeps three times and displays the screen on the right.

The meanings of the error codes in parentheses are as follows.

- ( X X )
- 1: The received data is different from the sent data.
  - 2: A timeout has occurred during standby for data reception.
- 1: 2400 bps
  - 2: 9600 bps
  - 3: 115200 bps
  - 4: 460800 bps

```

TEST COMMUNICATION
< OPTICAL >
** Test NG **
(XX)
    
```

Press and hold the **BS/C** key to return to the TEST COMMUNICATION menu.

The master BHT automatically returns to the TEST COMMUNICATION menu 10 seconds after the occurrence of an error.

Upon normal completion of the test, the tested slave BHT beeps once and displays the screen on the right.

Press and hold the **BS/C** key to return to the TEST COMMUNICATION menu.

The master BHT automatically returns to the TEST COMMUNICATION menu.

```

TEST COMMUNICATION
< OPTICAL >
** Test OK **
    
```

◆ Connector Communication Test

1. Wire the cable with JC-25-P-3 (φ2.5mm stereo mini-plug) as shown below and connect to the BHT connector communication port.

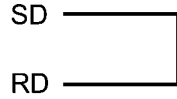

2. Select “2: CONNECTOR” at the TEST COMMUNICATION menu and then press the **ENT** key.

The TEST COMMUNICATION screen displays as shown on the right.

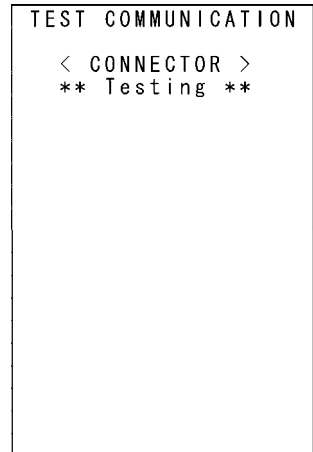

If an error occurs, the BHT beeps three times and displays the screen on the right.

The meanings of the error codes in parentheses are as follows.

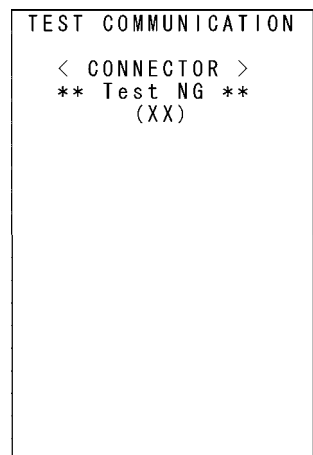
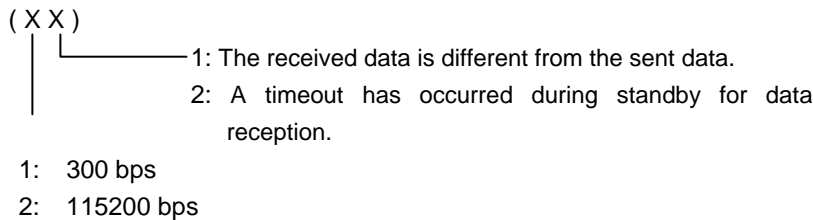

Press and hold the **BS/C** key to return to the TEST COMMUNICATION menu.

Upon normal completion of the test, the BHT beeps once and displays the screen on the right.

Press and hold the **BS/C** key to return to the TEST COMMUNICATION menu.

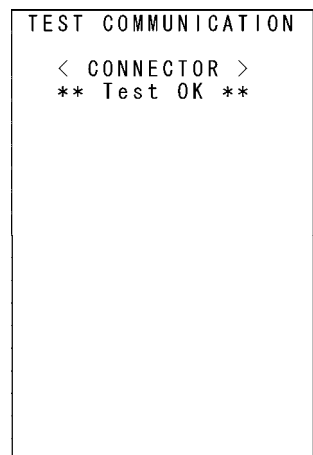

**[8] Key-entry, beeper and vibrator test**

Use the following procedure to perform a key entry, beeper and vibrator test.

1. Select "8: KEY & VIBRATION" at the TEST menu and then press the **ENT** key.

The screen on the right displays, and the BHT waits for key entry.

2. Press the **ENT** key.

Pressing individual keys displays the identifier letters in the positions pre-assigned to those keys on the LCD as well as sounding the beeper or activating the vibrator. (As long as the individual key is held down, the BHT continues to beep or vibrate.)

3. Press the same key again.

The displayed characters disappear.

4. Repeat the above operation to display all keys on the screen.

Upon completion of the test, the BHT automatically returns to the TEST menu.

Turn OFF the power to abort the test during testing.

The table below shows the relationship between the keys, the identifier letters to be displayed on the screen, and the frequencies (Hz) of the beeper.

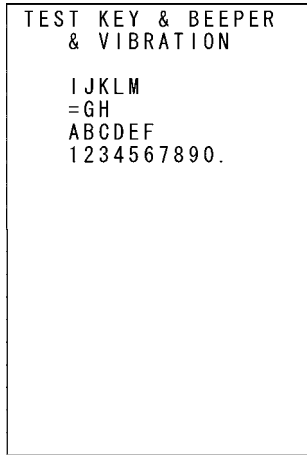
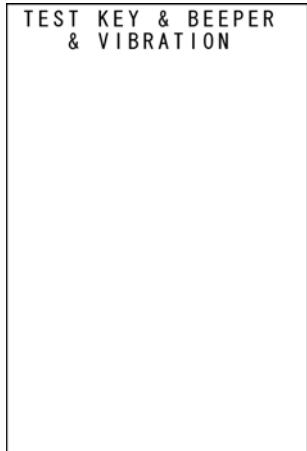

| Key      | Letter |     | Beeper (Hz) |
|----------|--------|-----|-------------|
| M1       | 'I'    | DO2 | 261         |
| M2       | 'J'    | RE2 | 293         |
| TRG1(M3) | 'K'    | Vib | Vibrator    |
| TRG2(M4) | 'L'    | Vib | Vibrator    |
| ▲        | 'C'    | MI2 | 329         |
| ▼        | 'D'    | FA2 | 349         |
| ◀        | 'E'    | SO2 | 391         |
| ▶        | 'F'    | RA2 | 440         |
| BS/C     | 'G'    | SI2 | 493         |
| ENT      | '='    | DO3 | 523         |
| 1        | '1'    | RE3 | 583         |
| 2        | '2'    | MI3 | 659         |
| 3        | '3'    | FA3 | 698         |
| 4        | '4'    | SO3 | 783         |
| 5        | '5'    | RA3 | 880         |
| 6        | '6'    | SI3 | 987         |
| 7        | '7'    | DO4 | 1046        |
| 8        | '8'    | RE4 | 1174        |
| 9        | '9'    | MI4 | 1318        |
| 0        | '0'    | FA4 | 1396        |
| .        | '.'    | SO4 | 1567        |
| MENU(M5) | 'M'    | RA4 | 1760        |
| F1       | 'A'    | SI4 | 1975        |
| F2       | 'B'    | DO5 | 2093        |
| SF       | 'H'    | RE5 | 2349        |

**[9] PING test**

(only on BHT-500B units equipped with software supporting LAN communication)

Use the following procedure to perform a PING test.

1. Select "9: PING" at the TEST menu and then press the **ENT** key.

The TEST PING screen displays as shown on the right.

- "1: RUN PING": Runs the PING test.  
 "2: SET PING": Displays the PING parameter setting screen.  
 "3: SET DEVICE": Displays the PING device setting screen.

Refer to the following section for details of the above items.

Press and hold the **BS/C** key to return to the TEST menu.

```

TEST PING
1:RUN PING
2:SET PING
3:SET DEVICE
  
```

◆ "1: RUN PING" (PING Test Screen)

1. Select "1: RUN PING" at the TEST PING menu and then press the **ENT** key.

The current setting values display, and the BHT waits for the transmission count to be entered.

To change the number of echo requests displayed, enter the desired value using the numerical keys.

To delete a single character, press the **BS/C** key.

Press and hold the **BS/C** key to delete all entries made.

```

RUN PING
DESTINATION IP
  XXX.XXX.XXX.XXX
DATA SIZE      XXXXX
INTERVAL      XXXXX
TIMEOUT       XXXXX
SEND TYPE     TYPE n
COUNT       [XXXXXX]
  
```

2. Press the **ENT** key.

When the PING test starts running, the message shown on the right displays.

Press and hold the **BS/C** key to abort the PING test.

```

RUN PING
**** PING Start ****
OK      : XXXXX
        [XXXXX]
NG      : XXXXX
TIMEOUT : XXXXX
IP xxx.xxx.xxx.xxx
  
```

Upon completion of the PING test, the screen on the right displays.

The PING result may include the following:

- OK: Displays the number of echo replies.
- [XXXXX]: Echo reply time in milliseconds
- NG: Displays the number of errors found during the PING test.
- TIMEOUT: Displays the number of timeouts (for echo replies) that took place during the PING test.
- IP: Displays the BHT IP address during the PING test only.

```
          RUN PING
**** PING Start ****
OK      : XXXXX
        [XXXXX]
NG      : XXXXX
TIMEOUT : XXXXX
**** PING End *****
```

**Messages displayed during PING test (displayed in center of screen)**

- Waiting: Setting up the PING test.
- Opening device: Opening devices.
- Routing TCP/IP: Connecting to the TCP/IP communication pathway.
- PING start: Starting the PING test.
- Device error: Failed to open a device.
- TCP/IP error: Failed to connect to the TCP/IP communication pathway.

**PING termination messages (displayed at bottom of screen)**

- PING end: The PING test has ended normally.
- PING aborted: The PING test has been aborted.
- PING error: An error has occurred during the PING test.

## ◆ “2: SET PING” (PING Options Setting Screen)

1. Select “2: SET PING” at the TEST PING menu and then press the **ENT** key.

The current settings are displayed.

[1: DESTINATION IP]:

Specifies the IP address of the host computer to be pinged.

[2:DATA SIZE]:

Specifies the data size of the echo request.

[3:INTERVAL]:

Specifies the echo request interval (in units of 100 ms).

[4:TIMEOUT]:

Specifies the timeout period (in units of 100 ms) for the echo request.

[5:COUNT]:

Specifies the number of echo requests to be sent.

[6:SEND TYPE]:

Selects the echo request send timing (TYPE 1 or TYPE 2).

(Refer to “PING Echo Request Transmission Timing (SEND TYPE)” on the following page for details.)

```

SET PING
1:DESTINATION IP
  [XXX.XXX.XXX.XXX]
2:DATA SIZE [XXXXXX]
3:INTERVAL [XXXXXX]
4:TIMEOUT [XXXXXX]
5:COUNT [XXXXXX]
6:SEND TYPE
  TYPE1 TYPE2
  
```

2. Use the cursor keys ([▲] [▼]) or numerical keys ([1] [2] [3] [4] [5] [6]) to highlight the item to be set, and then press the **ENT** key.

The mode changes to entry mode and the cursor displays.

Use the cursor keys ([◀] [▶]) to highlight the “6: SEND TYPE” setting.

3. Enter the setting values with the numerical keys and dot key.

To delete a single character, press the **BS/C** key.

Press and hold the **BS/C** key to delete all entries made.

4. Enter the setting values and then press the **ENT** key.

Press and hold the **BS/C** key to return to the TEST PING menu.

Entry Range for DATA SIZE, INTERVAL, TIMEOUT, and COUNT

| Item      | Allowable Entry range | Default |
|-----------|-----------------------|---------|
| DATA SIZE | 4 to 1472             | 56      |
| INTERVAL  | 0 to 65535            | 10      |
| TIMEOUT   | 0 to 65535            | 10      |
| COUNT     | 0* to 65535           | 4       |

\* Specifying zero (0) will set the number of echo requests to “infinite,” meaning that echo requests will be sent continuously until the PING test is aborted.

If a value outside the allowable entry range listed above is specified, the nearest value within the range will automatically be applied.

**PING Echo Request Transmission Timing (SEND TYPE)**

Two types of echo request send timings are available: TYPE 1 and TYPE 2.

**v TYPE1**

After sending an echo request, PING waits for the period specified at INTERVAL and then sends an echo request again. For TYPE 1, the relationship between the INTERVAL and TIMEOUT should be "INTERVAL ≥ TIMEOUT."

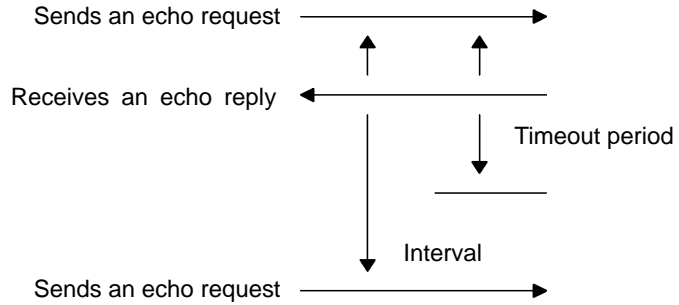

**v TYPE2**

After sending an echo request, PING waits for an echo reply to be received or for a timeout to occur. Following that, PING waits for the period specified at INTERVAL and then sends the next PING echo request. For TYPE 2, no relationship between the INTERVAL and TIMEOUT is required.

If PING receives an echo reply:

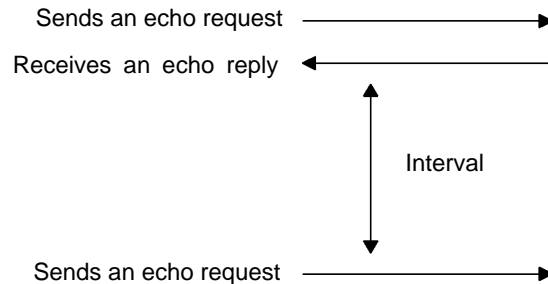

If a timeout occurs:

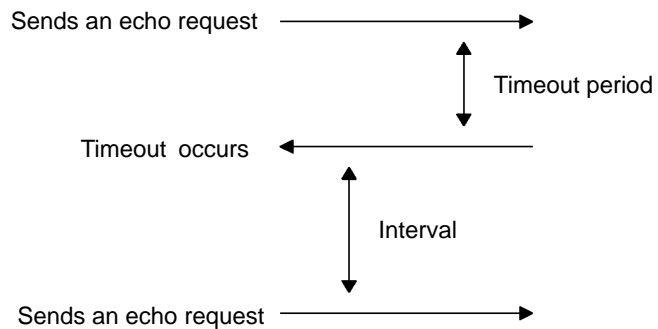

◆ “3: SET DEVICE” (PING Device Setting Screen) (when Equipped with Software Supporting LAN Communication)

1. Select “3: SET DEVICE” at the TEST PING menu and then press the **ENT** key.

The TCP/IP communication device, link layer, and transmission speed display.

Press and hold the **BS/C** key to return to the TEST PING menu.

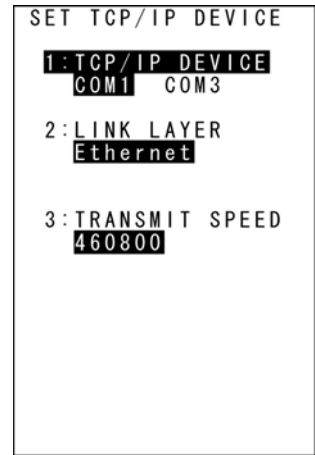



## 4.5.7 System Information (SYSTEM INFORMATION Menu)

### [1] Displaying the BHT system information

Use the following procedure to display the BHT system information.

1. Select "6: VERSION" at the SYSTEM MENU and then press the **ENT** key.

The SYSTEM INFORMATION screen on the right displays.

|                   |   |
|-------------------|---|
| [SYSTEM Ver.]:    | System program version                                  |
| [ROM SIZE]:       | ROM size  |
| [SYSTEM MESSAGE]: | System message version and loaded font type and version |

Press and hold the **BS/C** key to return to the SYSTEM MENU.

```

SYSTEM INFORMATION
SYSTEM Ver. : x.xx
ROM SIZE : xMB
SYSTEM MESSAGE:
           Japanese x.xx
FONT ENT

[F1]LICENSE INFO
    
```

2. Press the **ENT** key.

The loaded font type and version display.

Font type:  
 SJIS (FS): Free-size JIS1/2 font

```

SYSTEM INFORMATION
FONT :
  SJIS (FS) X.XX
    
```

◆ License List

Press the **F1** key at the LICENCE INFORMATION screen to display a license list as shown on the right.

The license list displays the names of functions for which licenses are required.

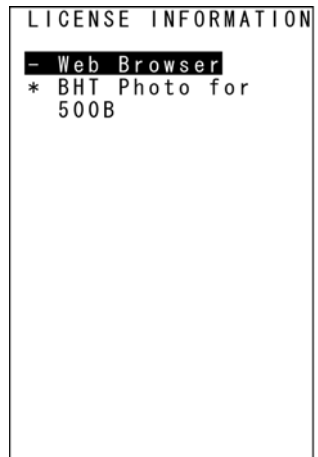

- [1] "\*" symbol: Indicates that a license has been registered.
- [2] "-" symbol: Indicates that no license has been registered.

\* Even if functions for which licenses are required are loaded in the system, these functions do not display in the list if they have never been run.

Press the **F1** key or press and hold the **BS/C** key to return to the SYSTEM INFORMATION screen.

[1] Functions for which licenses have been registered (\*)

1. Use the cursor keys ([▲] [▼]) to highlight the name of a function that has been registered, and then press the **ENT** key to display a screen similar to that shown on the right containing the license registration details.

[PRODUCT ID]: Product ID  
 [PRODUCT NAME]: Product name  
 [PRODUCT KEY]: Product key



2. Press and hold the **BS/C** key to return to the LICENSE INFORMATION screen.

[2] Functions for which licenses have not been registered (-)

1. Use the cursor keys ([▲] [▼]) to highlight the name of a function that has not been registered, and then press the **ENT** key to display the license registration screen shown on the right.

[PRODUCT ID]: Product ID  
 [PRODUCT NAME]: Product name  
 [PRODUCT KEY]: Product key

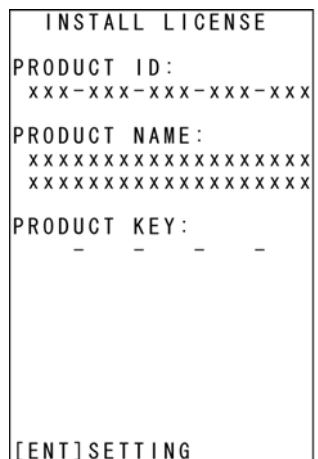

2. Press the **ENT** key to display the cursor, allowing the product key to be entered.

Enter the product key for the product ID, and then press the **ENT** key.

If "\*\*\* Authorized \*\*\*" displays, license registration is complete.

If "\*\*\*\* Key NG \*\*\*\*" displays, the entered product key is incorrect.

Reenter the correct product key.

\* The product key can be acquired when purchasing the product.

3. Press and hold the **BS/C** key to return to the LICENSE INFORMATION screen.

## [2] CU-511 System Information Display (when Equipped with Software Supporting LAN Communication)

Use the following procedure to display CU-511 system information.

1. Place the BHT on the CU-511.
2. Select "6: VERSION" at the SYSTEM MENU and then press the **ENT** key.

The SYSTEM INFORMATION screen on the right displays.

```

SYSTEM INFORMATION
SYSTEM Ver. : x.xx
ROM SIZE : xMB
SYSTEM MESSAGE:
      Japanese x.xx
FONT ENT
[F1]LICENSE INFO
    
```

3. Press the **M2** key.

The CU INFORMATION screen displays.

[SYSTEM Ver.]: System program information  
 [MAC ADDRESS]: MAC address

Press the **M1** key to return to the SYSTEM INFORMATION screen.

```

CU INFORMATION
SYSTEM Ver: 1.00
MAC : 00C059010000
    
```

If the **M2** key is pressed when the BHT is not on the CU-511, the screen on the right displays.

Press and hold the **BS/C** key to return to the SYSTEM INFORMATION screen.

```

CU INFORMATION
Info load failure.
-----
[ENT]Reload
[C]Return
    
```

## 4.5.8 Downloading/Uploading Files by FTP (FTP MENU)

(only on BHT-500B units equipped with software supporting LAN communication)

Use the following procedure to download and upload files by FTP.

1. Select "7: FTP" at the SYSTEM MENU and then press the **ENT** key.

The FTP MENU screen on the right displays.

"1: DOWNLOAD": Downloads a file by FTP.

"2: UPLOAD": Uploads a file(s) by FTP.

Refer to the following section for details of the above items.

Press and hold the **BS/C** key to return to the SYSTEM MENU.

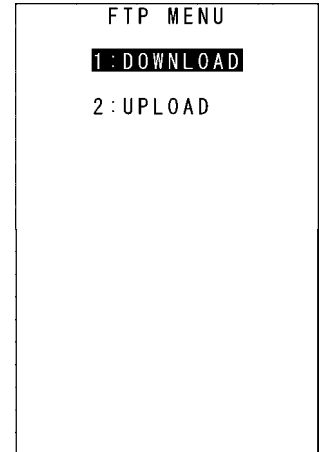

### [1] Downloading by FTP

1. Select "1: DOWNLOAD" at the FTP MENU and then press the **ENT** key.

The screen on the right displays.

[1: DIR/FILE]: Specifies the directory and/or file name.

[2: FIELDS]: Specifies field information for data files.

A message indicating the status displays at the bottom of the screen.

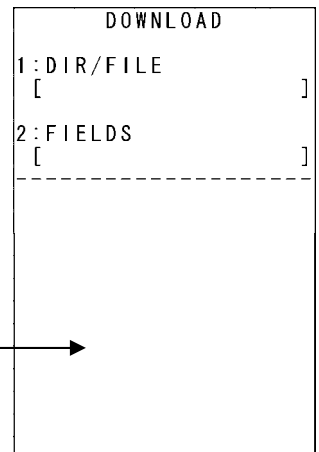

Press the **M2** key to display the screen on the right.

[SERVER IP]: Set IP address

[CURRENT DIRECTORY]: Acquired current directory

Press the **M1** key to return to the previous screen.

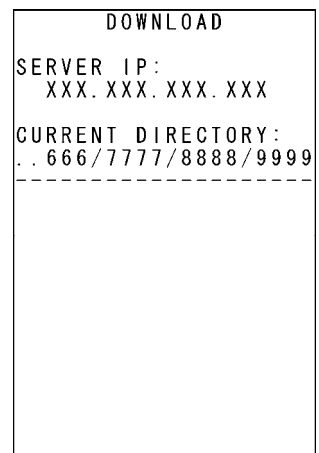

2. Use the cursor keys ([▲] [▼]) to highlight the item to be set, and then press the **ENT** key.

The mode changes to entry mode and the cursor displays.

3. Enter a setting value with the numerical keys and dot key.

Press the **SF** key to change the entry mode (numerical entry (no guidance display) and alphabet entry).

To delete a single character, press the **BS/C** key.

Press and hold the **BS/C** key to delete all entries made.

4. Enter a setting value and press the **ENT** key.

Press and hold the **BS/C** key to return to the FTP MENU screen.

DIR/FILE entry box: The FTP client will interpret a character string entered into this box as a directory name at first, and will therefore send a Change Directory request to the FTP server. If the specified directory exists in the FTP server, the server will change a directory from the default to the specified one; if not, the FTP client will interpret the entered character string as a file name and send a Download request to the server.

FIELDS entry box: It is only necessary to enter field information in this box when downloading a data file. Before starting downloading, enter field information using the numerical keys and dot key. Pressing the dot key will enter a comma [,]. No entry is required to download program files.

[2] Uploading by FTP

1. Select "2: UPLOAD" at the FTP MENU and then press the **ENT** key.

The screen on the right displays if uploadable files exist.

[1: DIR/FILE]:

Entry box for the directory and/or file name

[2: SELECT FILE]:

File name currently selected (Nothing is displayed at the FTP client initial status.)

A message indicating the status displays at the bottom of the screen.

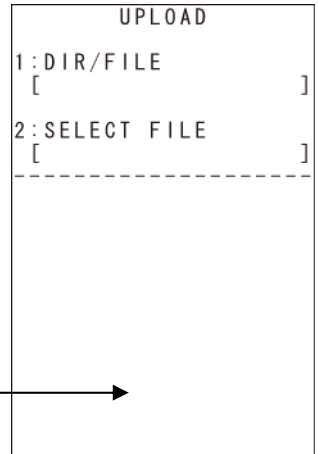

Press the **M2** key to display the screen on the right.

[SERVER IP]:

Set IP address

[CURRENT DIRECTORY]:

Acquired current directory

Press the **M1** key to return to the previous screen.

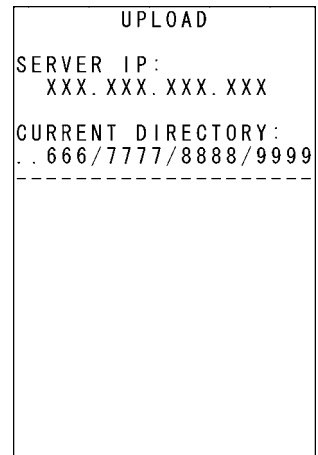

2. Use the cursor keys ([▲] [▼]) to highlight the item to be set, and then press the **ENT** key.

◆ When "1: DIR/FILE" is Selected

The mode changes to entry mode and the cursor displays, allowing directory and file names to be entered using the numerical keys and dot key.

Press the **SF** key to change the entry mode (numerical entry (no guidance display) and alphabet entry).

To delete a single character, press the **BS/C** key.

Press and hold the **BS/C** key to delete all entries made.

◆ When "2: SELECT FILE" is Selected

The screen on the right displays.

Use the cursor keys ([▲] [▼]) to highlight the upload file and then press the **ENT** key.

Return to the previous screen to display the selected file name in [2: FIELDS]

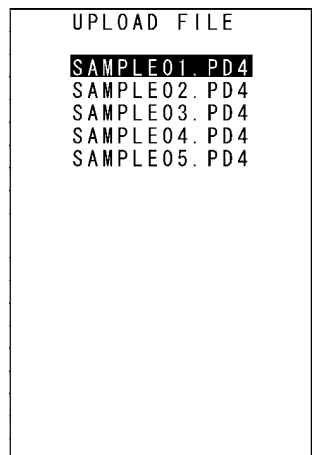

**3.** Enter the directory and file name, or select a file, and then press the **ENT** key.

Press and hold the **BS/C** key to return to the FTP MENU screen.

DIR/FILE entry box: The FTP client will interpret a character string entered into this box as a directory name at first, and will therefore send a Change Directory request to the FTP server. If the specified directory exists in the FTP server, the server will change a directory from the default to the specified one; if not, the FTP client will interpret the entered character string as a file name and send a Download request to the server.

If the SELECT FILE entry box file name differs from the file name specified in the DIR/FILE entry box, the FTP client will upload with the file name specified in the DIR/FILE entry box.

If the **ENT** key is pressed without entering a character string in the DIR/FILE entry box, the FTP client will upload to the server with the SELECT FILE entry box file name.

SELECT FILE entry box: For uploading, it is necessary to select a file to be uploaded to display the name in this entry box beforehand. Without a file name in this entry box, uploading will result in an error.

If the attributes (e.g., PD4, FN4, EX4, PD3, FN3, EX3, and data file extensions) of the selected file are different from those specified in the DIR/FILE entry box, an error will result.

**If No Uploadable Files Exist**

If no file exists in the BHT when uploading by FPT is selected, the message shown on the right displays.

Press and hold the **BS/C** key to return to the FTP MENU screen.

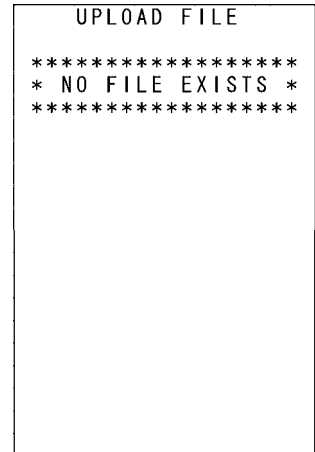

**FTP Download/Upload Messages**

When the BHT is uploading or downloading files by FTP, the following messages will appear at the bottom of the screen:

|                      |   |  |
|----------------------|---|--|
| Aborted.             | : | Uploading or downloading has been interrupted.   |
| Connection error     | : | The communication pathway is disconnected.   |
| Device error         | : | Failed to open a device.   |
| Downloading          | : | Downloading starts.  |
| Download failed      | : | Downloading has ended abnormally.  |
| Download finished    | : | Downloading has ended normally.  |
| File broken!         | : | The file being uploaded is corrupt.  |
| File not found!      | : | No file is found when downloading.   |
| File not selected    | : | No file has been selected.   |
| File type mismatch!  | : | When uploading, the attributes of the file selected in the SELECT FILE entry box are different from those in the DIR/FILE entry box. |
| FTP error            | : | An error has occurred during execution of an FTP command.  |
| FTP opened           | : | Connection has been established by FTP.  |
| Illegal text format! | : | The format of the received text is illegal.  |
| Opening device       | : | Opening a device.  |
| Out of memory!       | : | The memory is insufficient for storing files to be downloaded.   |
| Out of range!        | : | The specified parameter(s) is out of the allowable range.  |
| Parameter error!     | : | When downloading, the record length and/or field length specified in the FIELDS entry box exceed 255.                                |
| Program file error!  | : | The received program file is illegal.  |
| Routing TCP/IP       | : | Connecting to the TCP/IP communications pathway.   |
| Syntax error!        | : | A syntax error has occurred.   |
| TCP/IP error         | : | Failed to connect to the TCP/IP communication pathway.   |
| TCP socket error     | : | An error occurred in the TCP layer during execution of an FTP command.   |
| Too many files!      | : | The current download will exceed the allowable number of files in the memory.  |
| Uploading            | : | Uploading starts.  |
| Upload failed        | : | Uploading has ended abnormally.  |
| Upload finished      | : | Uploading has ended normally.  |



**Response Messages from the FTP server**

The messages that FTP servers send during and after FTP operations vary, but servers all use the same reply codes as listed below.

- 110 : Restart marker reply
- 120 : Service ready in approx. nnn minutes.
- 125 : Data connection has been established. Start transferring.
- 150 : File status okay: establishing data connection.
- 200 : Command okay
- 202 : No response to this command. Not required at this site.
- 211 : System status, or system help reply
- 212 : Directory status
- 213 : File status
- 214 : Help message
- 215 : NAME system type
- 220 : Service ready for new users.
- 221 : Service closing control connection.
- 225 : Data connection established: no transfer in progress.
- 226 : Closing data connection.
- 227 : Entering Passive Mode.
- 230 : User logged in. Proceed.
- 250 : Requested file process completed normally.
- 257 : "PATHNAME" created.
- 331 : User name okay. Password required.
- 332 : Login account required.
- 350 : Requested file process awaiting further information.
- 421 : Service not available. Closing control connection.
- 425 : Unable to establish data connection.
- 426 : Connection closed: transfer aborted.
- 450 : Requested file action not taken.
- 451 : Requested action aborted: processing local error.
- 452 : Requested action not taken.
- 500 : Syntax error; command not recognized.
- 501 : Syntax error in parameters or arguments.
- 502 : Command not supported.
- 503 : Incorrect command sequence
- 504 : Command parameter not supported.
- 530 : Not logged in.
- 532 : File storage account required.
- 550 : Requested action not taken.
- 551 : Requested action aborted: page type unknown.
- 552 : Requested file processing aborted.
- 553 : Requested action not taken.

## 4.5.9 Wireless Communication Settings (RF MENU)

(\* BHT-504BW Only)

Use the following procedure to perform wireless communication settings.

1. Select "8: RF" at the SYSTEM MENU and then press the **ENT** key.

The RF MENU screen on the right displays.

- [1: PARAMETER]: Performs wireless parameter settings.  
 [2: SITE SURVEY]: Performs site survey settings.  
 [3: VERSION]: Displays the wireless version.

Refer to the following section for details of the above items.  
 Press and hold the **BS/C** key to return to the SYSTEM MENU.



### [1] Wireless parameter settings menu

1. Select "1: PARAMETER" at the RF MENU and then press the **ENT** key.

The SET RF PARAMETER screen on the right displays.

Wireless Parameter Settings

- [1: RF NETWORK]: Performs wireless network settings.  
 [2: SECURITY]: Performs wireless security settings.  
 [3: INITIALIZE]: Performs wireless parameter initialization.

Refer to the following section for details of the above items.  
 Press and hold the **BS/C** key to return to the RF MENU screen.

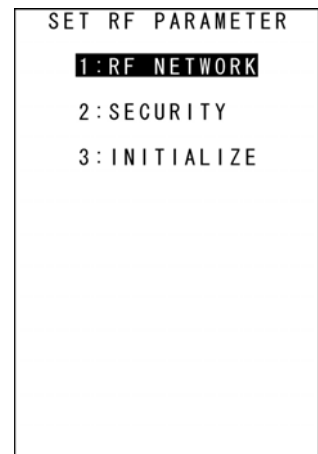

### ◆ Wireless Network Settings Menu

1. Select "1: RF NETWORK" at the SET RF PARAMETER menu and then press the **ENT** key.

The SET RF PARAMETER screen on the right displays.

- [1: NETWORK PARAMETER]: Performs wireless network parameter settings.  
 [2: RF OPTION]: Performs wireless network option settings.

Refer to the following section for details of the above items.  
 Press and hold the **BS/C** key to return to the SET RF PARAMETER screen.

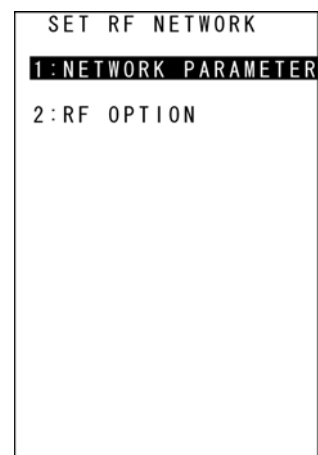

◆ **Wireless Network Parameter Settings**

1. Select “1: NETWORK PARAMETER” at the SET RF NETWORK menu and then press the **ENT** key.

The screen on the right displays.

[1: SSID]: Displays the current Service Set ID.

Refer to “Chapter 5 Communication” – “5.3 Wireless Communication” for details on the Service Set ID.

2. Ensure that [1: SSID] is highlighted and press the **ENT** key.

The mode changes to entry mode and the cursor displays.

3. Use the numerical keys and dot key to enter the Service Set ID.

Press the **SF** key to change the entry mode (numerical entry (no guidance display) and alphabet entry).  
To delete a single character, press the **BS/C** key.  
Press and hold the **BS/C** key to delete all entries made.

4. Enter the Service Set ID and press the **ENT** key.

The entered Service Set ID is set.

5. Press and hold the **BS/C** key to return to the SET RF NETWORK screen.

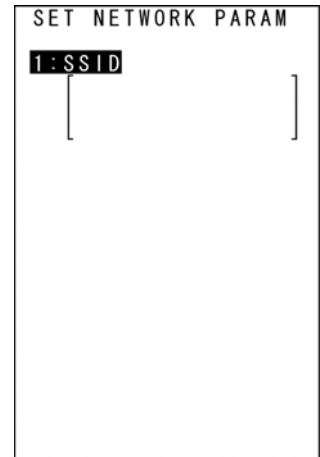

◆ **Wireless Network Option Settings**

1. Select “2: RF OPTION” at the SET RF NETWORK menu and then press the **ENT** key.

The screen on the right displays.  
The highlighted settings are the current settings.

[1: POWER SAVE]: Sets power saving mode.  
[2: RADIO MODE]: Sets the wireless mode.

2. Use the cursor keys ([▲] [▼]) or numerical keys ([1] [2]) to highlight the item to be set.

3. Use the cursor keys ([◀] [▶]) to highlight each setting value.

4. Press the **ENT** key or press and hold the **BS/C** key to return to the SET RF NETWORK menu.

Refer to “Chapter 5 Communication” – “5.3 Wireless Communication” for details of the above setting items.

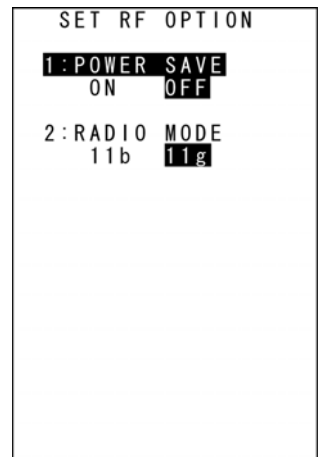



◆ **Wireless Security None Mode**

WEP can be used with the Wireless security None mode.

To enable WEP, WEP and WEP KEY settings are required.

The first WEP KEY setting is the encryption key, which can be set from WEP KEY 1 to 4.

After setting the encryption key, the encryption key used is specified by setting the TRANSMIT KEY.

Refer to “Chapter 5 Communication” – “5.3 Wireless Communication” for details of the WEP KEY and TRANSMIT KEY.

1. Select “2: CONFIGURATION” at the SET SECURITY menu and then press the **ENT** key.

The screen on the right displays.

- [1: WEP OPTION]: WEP option settings
- [2: WEP KEY1]: WEP KEY 1 settings
- [3: WEP KEY2]: WEP KEY 2 settings
- [4: WEP KEY3]: WEP KEY 3 settings
- [5: WEP KEY4]: WEP KEY 4 settings
- [6: TRANSMIT KEY]: TRANSMIT KEY settings

Press and hold the **BS/C** key to return to the SET SECURITY menu

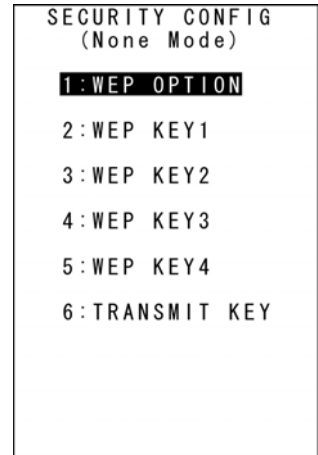

2. Use the cursor keys ([▲] [▼]) or numerical key ([1]) to highlight [1: WEP OPTION], and then press the **ENT** key.

The screen on the right displays.

- [1: WEP]: Selects whether to enable or disable WEP. The highlighted setting is the current setting.
- [2: AUTHENTICATE]: Selects open system settings or shared key authentication. Select shared key authentication. The highlighted setting is the current setting.

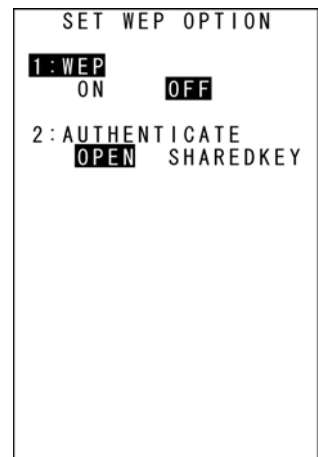

3. Press the **ENT** key or press and hold the **BS/C** key to return to the SET RF PARAMETER menu.

4. Use the cursor keys ([▲] [▼]) or numerical keys ([2] [3] [4] [5]) to highlight a WEP KEY from 1 to 4, and then press the **ENT** key.

The screen on the right displays.

[1: KEY SIZE]:

Select 40 (40 bits) or 128 (128 bit).

The highlighted setting is the current setting.

When no encryption key has been set, 40 will be highlighted.

[2: KEY]:

If the encryption key has been set, the key size “\*” displays.

When no encryption key has been set, this field is empty.

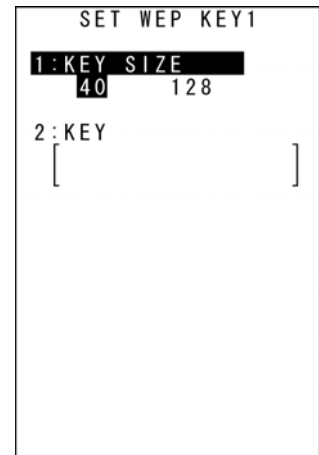

5. Use the cursor keys ([▲] [▼]) or numerical key ([1]) to highlight [1: KEY SIZE], and then use the cursor keys ([◀] [▶]) to select either 40 (40 bit) or 128 (128 bit).

Select 40 bit for a 10-digit encryption key.

Select 128 bit for a 26-digit encryption key.

6. Use the cursor keys ([▲] [▼]) or numerical key ([2]) to highlight [2: KEY], and then press the **ENT** key.

The mode changes to entry mode and the cursor displays.

7. Use the numerical keys to enter an encryption key and then press the **ENT** key.

Hexadecimal notation (0, 1, 2, 3, 4, 5, 6, 7, 8, 9, A, B, C, D, E, F) is used for the encryption key.

Press the **SF** key to change the entry mode (numerical entry (no guidance display) and alphabet entry).

To delete a single character, press the **BS/C** key.

Press and hold the **BS/C** key to delete all entries made.

The existing key can be overwritten, however, cannot be edited or deleted.

The screen on the right shows an example in which “40 bit” has been set for “WEP KEY1” and the key setting is “ABCDE12345”.

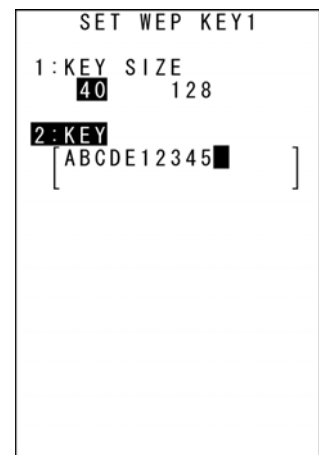

8. Press and hold the **BS/C** key to return to the SET RF PARAMETER menu.

---

- Point - It is not possible to read a written WEP key, and therefore the WEP key setting must always be stored in a safe location. When not setting a WEP key, the WEP key will be the same as the previous setting.

---

If an attempt is made to save an incorrect encryption key, and error will occur, and the screen on the right displays.

Reset with a correct encryption key.

**Incorrect Encryption Key Examples**

- The encryption key length is incorrect.
- Characters other than hexadecimal notation (0, 1, 2, 3, 4, 5, 6, 7, 8, 9, A, B, C, D, E, F) are used.

Repeat the above procedure to set the required number of encryption keys for WEP KEY 1 to 4.

Following that, set the transmit key.

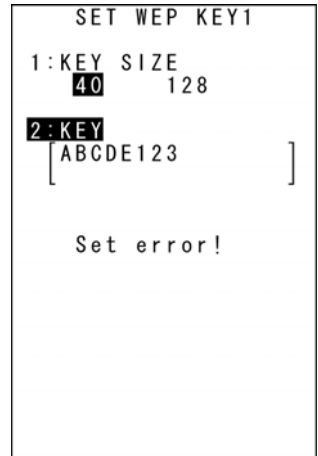

9. Use the cursor keys ([▲] [▼]) or numerical key ([6]) to highlight [6: TRANSMIT KEY], and then press the **ENT** key.

The screen on the right displays.



10. Use the cursor keys ([◀] [▶]) to highlight the key number to be used.

---

- Point - Select a key number for which an encryption key has been set.

---

11. Press the **ENT** key or press and hold the **BS/C** key to return to the SET RF PARAMETER menu.

## ◆ Wireless Security 1x Supplicant Mode

EAP authentication can be used with wireless security 1x Supplicant mode.

1. Select "2: CONFIGURATION" at the SET SECURITY menu and then press the **ENT** key.

The screen on the right displays.

[1: AUTH PARAM (EAP)]: EAP authentication parameter setting

Press and hold the **BS/C** key to return to the SET SECURITY menu.

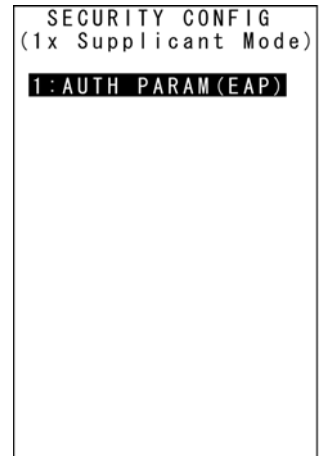

2. Ensure that [1: AUTH PARAM (EAP)] is highlighted and then press the **ENT** key.

The screen on the right displays.

[1: EAP TYPE]: Selects PEAP or EAP-TLS.

[2: IDENTITY]: ID

[3: ANONYMOUS ID]: Anonymous ID

[4: PASSWORD]: Password

[5: ROOT CERT]: Root certificate

[6: CLIENT CERT]: Client certificate

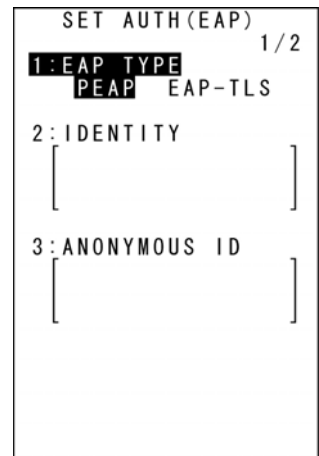

[▲] key / [▼] key

3. Use the cursor keys ([▲] [▼]) or numerical key ([1]) to highlight [1: EAP TYPE], and then use the cursor keys ([◀] [▶]) to select PEAP or EAP-TLS.

If PEAP is selected, a root certificate is used.

If EAP-TLS is selected, a root certificate and client certificate are used.

4. Use the cursor keys ([▲] [▼]) or numerical key ([2]) to highlight [2: IDENTITY] and then press the **ENT** key.

The mode changes to entry mode and the cursor displays.

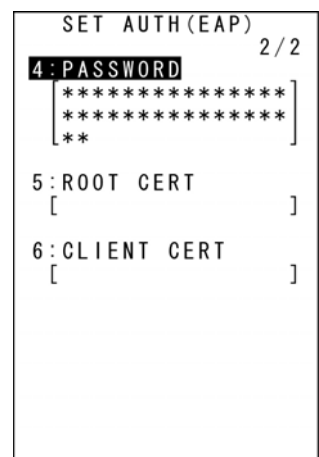



**5.** Use the numerical keys to enter an ID and press the **ENT** key.

Press the **SF** key to change the entry mode (numerical entry (no guidance display) and alphabet entry).  
 To delete a single character, press the **BS/C** key.  
 Press and hold the **BS/C** key to delete all entries made.

**6.** Use the cursor keys ([▲] [▼]) or numerical key ([3]) to highlight [3: ANONYMOUS ID] and then press the **ENT** key.

The mode changes to entry mode and the cursor displays.

**7.** Use the numerical keys to enter an ID and press the **ENT** key.

Press the **SF** key to change the entry mode (numerical entry (no guidance display) and alphabet entry).  
 To delete a single character, press the **BS/C** key.  
 Press and hold the **BS/C** key to delete all entries made.

**8.** Use the cursor keys ([▲] [▼]) or numerical key ([4]) to highlight [4: PASSWORD] and then press the **ENT** key.

The mode changes to entry mode and the cursor displays.

**9.** Use the numerical keys to enter a password and press the **ENT** key.

Press the **SF** key to change the entry mode (numerical entry (no guidance display) and alphabet entry).  
 To delete a single character, press the **BS/C** key.  
 Press and hold the **BS/C** key to delete all entries made.

**10.** Use the cursor keys ([▲] [▼]) or numerical key ([5]) to highlight [5: ROOT CERT] and then press the **ENT** key.

The screen on the right displays.

Use the cursor keys ([▲] [▼]) to select a file name.  
 A "NO FILE EXISTS" message displays if no files exist.

**11.** Use the cursor keys ([▲] [▼]) or numerical key ([6]) to highlight [6: CLIENT CERT] and then press the **ENT** key.

The same screen as that for [5: ROOT CERT] displays.  
 Use the cursor keys ([▲] [▼]) to select a file name.  
 A "NO FILE EXISTS" message displays if no files exist.

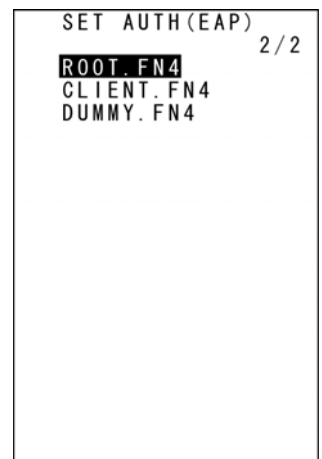

**12.** Press and hold the **BS/C** key to return to the SET RF PARAMETER menu.

## ◆ Wireless Security WPA-1x Mode

EAP authentication and an encryption system can be used with wireless security WPA-1x mode.

1. Select "2: CONFIGURATION" at the SET SECURITY menu and then press the **ENT** key.

The screen on the right displays.

[1: AUTH PARAM (EAP)]: EAP authentication parameter setting  
[2: WPA CIPHER]: Encryption system setting

Press and hold the **BS/C** key to return to the SET SECURITY menu.

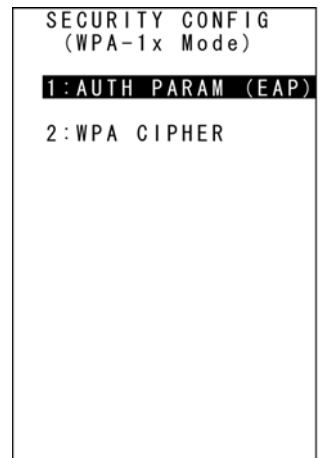

2. Use the cursor keys ([▲] [▼]) or numerical key ([1]) to highlight [1: AUTH PARAM (EAP)] and then press the **ENT** key.

The screen on the right displays.

[1: EAP TYPE]: Selects PEAP or EAP-TLS.  
[2: IDENTITY]: ID  
[3: ANONYMOUS ID]: Anonymous ID  
[4: PASSWORD]: Password  
[5: ROOT CERT]: Root certificate  
[6: CLIENT CERT]: Client certificate

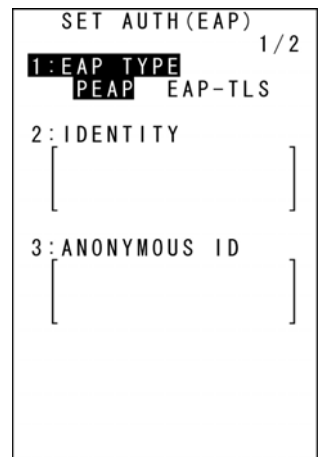

[▲] key / [▼] key

3. Use the cursor keys ([▲] [▼]) or numerical key ([1]) to highlight [1: EAP TYPE], and then use the cursor keys ([◀] [▶]) to select PEAP or EAP-TLS.

If PEAP is selected, a root certificate is used.

If EAP-TLS is selected, a root certificate and client certificate are used.

4. Use the cursor keys ([▲] [▼]) or numerical key ([2]) to highlight [2: IDENTITY] and then press the **ENT** key.

The mode changes to entry mode and the cursor displays.

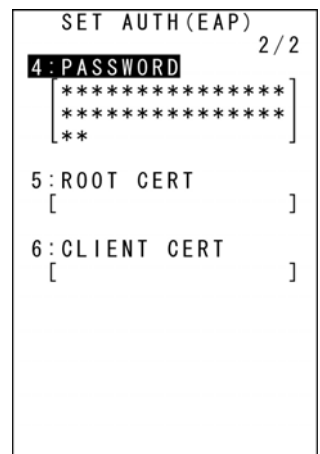

5. Use the numerical keys to enter an ID and press the **ENT** key.

Press the **SF** key to change the entry mode (numerical entry (no guidance display) and alphabet entry).  
 To delete a single character, press the **BS/C** key.  
 Press and hold the **BS/C** key to delete all entries made.

6. Use the cursor keys ([▲] [▼]) or numerical key ([3]) to highlight [3: ANONYMOUS ID] and then press the **ENT** key.

The mode changes to entry mode and the cursor displays.

7. Use the numerical keys to enter an ID and press the **ENT** key.

Press the **SF** key to change the entry mode (numerical entry (no guidance display) and alphabet entry).  
 To delete a single character, press the **BS/C** key.  
 Press and hold the **BS/C** key to delete all entries made.

8. Use the cursor keys ([▲] [▼]) or numerical key ([4]) to highlight [4: PASSWORD] and then press the **ENT** key.

The mode changes to entry mode and the cursor displays.

9. Use the numerical keys to enter a password and press the **ENT** key.

Press the **SF** key to change the entry mode (numerical entry (no guidance display) and alphabet entry).  
 To delete a single character, press the **BS/C** key.  
 Press and hold the **BS/C** key to delete all entries made.

10. Use the cursor keys ([▲] [▼]) or numerical key ([5]) to highlight [5: ROOT CERT] and then press the **ENT** key.

The screen on the right displays.

Use the cursor keys ([▲] [▼]) to select a file name.  
 A "NO FILE EXISTS" message displays if no files exist.

11. Use the cursor keys ([▲] [▼]) or numerical key ([6]) to highlight [6: CLIENT CERT] and then press the **ENT** key.

The same screen as that for [5: ROOT CERT] displays.  
 Use the cursor keys ([▲] [▼]) to select a file name.  
 A "NO FILE EXISTS" message displays if no files exist.



12. Press and hold the **BS/C** key to return to the SET RF PARAMETER menu.

- 13.** Use the cursor keys ([▲] [▼]) or numerical key ([2]) to highlight [2: WPA CIPHER] and then press the **ENT** key.

The screen on the right displays.

[1: CIPHER MODE]: Selects TKIP or AES.

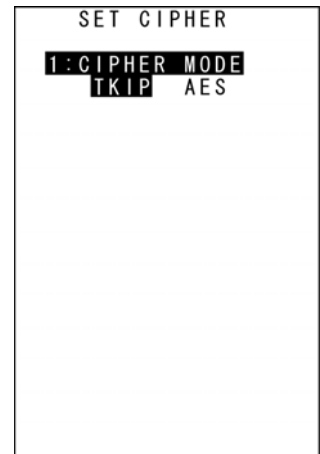

- 14.** Ensure that [1: CIPHER MODE] is highlighted and then select TKIP or AES.

Select TKIP to use TKIP.

Select AES to use AES.

- 15.** Press the **ENT** key or press and hold the **BS/C** key to return to the SET RF PARAMETER menu.

#### ◆ Wireless Security WPA-PSK Mode

PSK authentication and an encryption system can be used with wireless security WPA-PSK mode.

- 1.** Select “2: CONFIGURATION” at the SET SECURITY menu and then press the **ENT** key.

The screen on the right displays.

[1: AUTH PARAM (PSK)]: PSK authentication parameter setting

[2: WPA CIPHER]: Encryption system setting

Press and hold the **BS/C** key to return to the SET SECURITY menu.



- 2.** Use the cursor keys ([▲] [▼]) or numerical key ([1]) to highlight [1: AUTH PARAM (PSK)] and then press the **ENT** key.

The screen on the right displays.

[1: PRE SHARED KEY]: Sets the shared key.

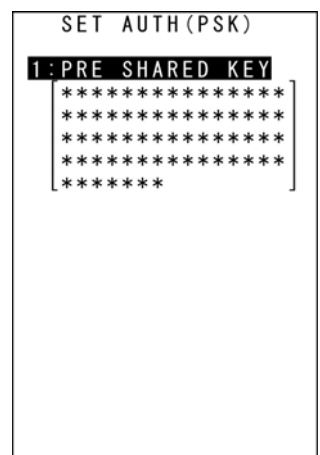

3. Ensure that [1: PRE SHARED KEY] is highlighted and then press the **ENT** key.

The mode changes to entry mode and the cursor displays.

4. Use the numerical keys to enter a shared key and press the **ENT** key.

Press the **SF** key to change the entry mode (numerical entry (no guidance display) and alphabet entry).

To delete a single character, press the **BS/C** key.

Press and hold the **BS/C** key to delete all entries made.

5. Press and hold the **BS/C** key to return to the SET RF PARAMETER menu.

6. Use the cursor keys ([▲] [▼]) or numerical key ([2]) to highlight [2: WPA CIPHER] and then press the **ENT** key.

The screen on the right displays.

[1: CIPHER MODE]: Selects TKIP or AES.

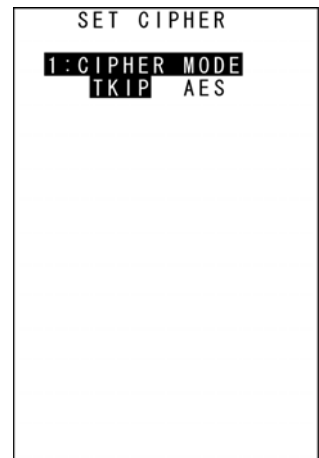

7. Ensure that [1: CIPHER MODE] is highlighted and then select TKIP or AES.

Select TKIP to use TKIP.

Select AES to use AES.

8. Press the **ENT** key or press and hold the **BS/C** key to return to the SET RF PARAMETER menu.

◆ **Wireless Security WPA2-1x Mode (when Equipped with Software Supporting WPA2)**

EAP authentication and an encryption system can be used with wireless security WPA2-1x mode.

1. Select "2: CONFIGURATION" at the SET SECURITY menu and then press the **ENT** key.

The screen on the right displays.

[1: AUTH PARAM (EAP)]: EAP authentication parameter setting

[2: WPA CIPHER]: Encryption system setting

Press and hold the **BS/C** key to return to the SET SECURITY menu.

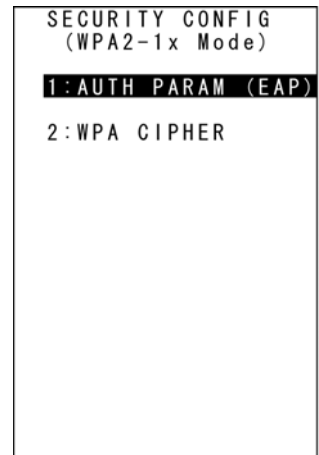

- Use the cursor keys ([▲] [▼]) or numerical key ([1]) to highlight [1: AUTH PARAM (EAP)] and then press the **ENT** key.

The screen on the right displays.

[1: EAP TYPE]:       Selects PEAP or EAP-TLS.  
 [2: IDENTITY]:        ID  
 [3: ANONYMOUS ID]: Anonymous ID  
 [4: PASSWORD]:        Password  
 [5: ROOT CERT]:       Root certificate  
 [6: CLIENT CERT]:     Client certificate

```

SET AUTH(EAP) 1/2
1: EAP TYPE
   PEAP  EAP-TLS
2: IDENTITY
   [
3: ANONYMOUS ID
   ]

```

[▲] key / [▼] key

- Use the cursor keys ([▲] [▼]) or numerical key ([1]) to highlight [1: EAP TYPE], and then use the cursor keys ([◀] [▶]) to select PEAP or EAP-TLS.

If PEAP is selected, a root certificate is used.

If EAP-TLS is selected, a root certificate and client certificate are used.

- Use the cursor keys ([▲] [▼]) or numerical key ([2]) to highlight [2: IDENTITY] and then press the **ENT** key.

The mode changes to entry mode and the cursor displays.

```

SET AUTH(EAP) 2/2
4: PASSWORD
   [*****]
   [*****]
   [**]
5: ROOT CERT
   [
6: CLIENT CERT
   ]

```

- Use the numerical keys to enter an ID and press the **ENT** key.

Press the **SF** key to change the entry mode (numerical entry (no guidance display) and alphabet entry).

To delete a single character, press the **BS/C** key.

Press and hold the **BS/C** key to delete all entries made.

- Use the cursor keys ([▲] [▼]) or numerical key ([3]) to highlight [3: ANONYMOUS ID] and then press the **ENT** key.

The mode changes to entry mode and the cursor displays.

- Use the numerical keys to enter an ID and press the **ENT** key.

Press the **SF** key to change the entry mode (numerical entry (no guidance display) and alphabet entry).

To delete a single character, press the **BS/C** key.

Press and hold the **BS/C** key to delete all entries made.

8. Use the cursor keys ([▲] [▼]) or numerical key ([4]) to highlight [4: PASSWORD] and then press the **ENT** key.

The mode changes to entry mode and the cursor displays.

9. Use the numerical keys to enter a password and press the **ENT** key.

Press the **SF** key to change the entry mode (numerical entry (no guidance display) and alphabet entry).

To delete a single character, press the **BS/C** key.

Press and hold the **BS/C** key to delete all entries made.

10. Use the cursor keys ([▲] [▼]) or numerical key ([5]) to highlight [5: ROOT CERT] and then press the **ENT** key.

The screen on the right displays.

Use the cursor keys ([▲] [▼]) to select a file name.

A "NO FILE EXISTS" message displays if no files exist.



11. Use the cursor keys ([▲] [▼]) or numerical key ([6]) to highlight [6: CLIENT CERT] and then press the **ENT** key.

The same screen as that for [5: ROOT CERT] displays.

Use the cursor keys ([▲] [▼]) to select a file name.

A "NO FILE EXISTS" message displays if no files exist.

12. Press and hold the **BS/C** key to return to the SET RF PARAMETER menu.

13. Use the cursor keys ([▲] [▼]) or numerical key ([2]) to highlight [2: WPA CIPHER] and then press the **ENT** key.

The screen on the right displays.

[1:CIPHER MODE]: Selects TKIP or AES.



14. Ensure that [1: CIPHER MODE] is highlighted and then select TKIP or AES.

Select TKIP to use TKIP.

Select AES to use AES.

15. Press the **ENT** key or press and hold the **BS/C** key to return to the SET RF PARAMETER menu.

## ◆ Wireless Security WPA2-PSK Mode (when Equipped with Software Supporting WPA2)

PSK authentication and an encryption system can be used with wireless security WPA2-PSK mode.

1. Select "2: CONFIGURATION" at the SET SECURITY menu and then press the **ENT** key.

The screen on the right displays.

[1: AUTH PARAM (PSK)]: PSK authentication parameter setting  
[2: WPA CIPHER]: Encryption system setting

Press and hold the **BS/C** key to return to the SET SECURITY menu.



2. Use the cursor keys ([▲] [▼]) or numerical key ([1]) to highlight [1: AUTH PARAM (PSK)] and then press the **ENT** key.

The screen on the right displays.

[1:PRE SHARED KEY]: Sets the shared key.

3. Ensure that [1: PRE SHARED KEY] is highlighted and then press the **ENT** key.

The mode changes to entry mode and the cursor displays.

4. Use the numerical keys to enter a shared key and press the **ENT** key.

Press the **SF** key to change the entry mode (numerical entry (no guidance display) and alphabet entry).

To delete a single character, press the **BS/C** key.

Press and hold the **BS/C** key to delete all entries made.

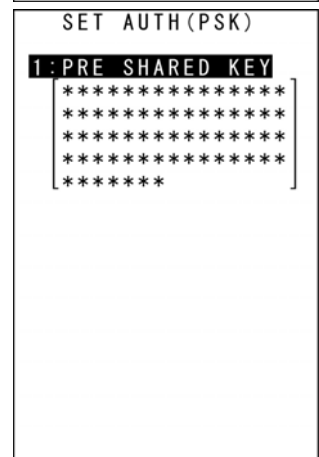

5. Press and hold the **BS/C** key to return to the SET RF PARAMETER menu.

6. Use the cursor keys ([▲] [▼]) or numerical key ([2]) to highlight [2: WPA CIPHER] and then press the **ENT** key.

The screen on the right displays.

[1:CIPHER MODE]: Selects TKIP or AES.

7. Ensure that [1: CIPHER MODE] is highlighted and then select TKIP or AES.

Select TKIP to use TKIP.

Select AES to use AES.

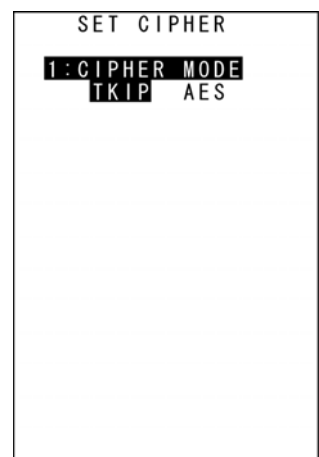



8. Press the **ENT** key or press and hold the **BS/C** key to return to the SET RF PARAMETER menu.

◆ **Wireless Parameter Initialization**

1. Select “3: INITIALIZE” at the SET RF PARAMETER menu and then press the **ENT** key.

The screen on the right displays.

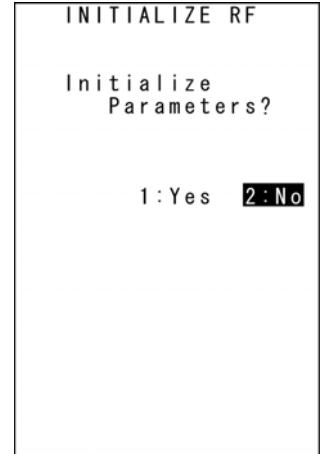

**To initialize wireless parameters:**

Use the cursor keys ([▲] [▼]) or numerical key ([1]) to highlight [1: Yes] and then press the **ENT** key.

Wireless parameters are initialized and the screen returns to the SET RF PARAMETER menu.

**To cancel:**

Use the cursor keys ([▲] [▼]) or numerical key ([2]) to highlight [2: No] and then press the **ENT** key.

The screen returns to the SET RF PARAMETER menu.

◆ **EAP Authentication Option Setting**

This setting can be used when the mode is set to other than “1: None” at the SET SECURITY MODE menu.

1. Press the **SF** key and dot key at the SET RF PARAMETER menu.

The screen on the right displays.

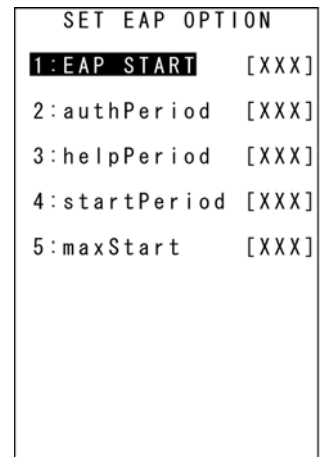

- [1: EAP START]: EAP authentication start time
- [2: authPeriod]: Retry interval when there is no response
- [3: helpPeriod]: Retry interval when authentication fails
- [4: startPeriod]: Start retry interval
- [5: maxStart]: Start retry count

2. Use the cursor keys ([▲] [▼]) or numerical keys ([1] [2] [3] [4] [5]) to highlight the item to be set and press the **ENT** key.

The mode changes to entry mode and the cursor displays.

3. Enter each item with the numerical keys and press the **ENT** key.

To delete a single character, press the **BS/C** key.  
 Press and hold the **BS/C** key to delete all entries made.

4. Press and hold the **BS/C** key to return to the the SET RF PARAMETER menu.

[2] Site Survey Menu

1. Select "2: SITE SURVEY" at the RF MENU and then press the **ENT** key.

The SITE SURVEY screen on the right displays.

Press and hold the **BS/C** key to return to the RF MENU screen.



2. Press the **ENT** key.

The current communication status displays in real time.

[ASSOCIATED AP]:

Displays the MAC address of the wireless interface for the associated access point.

[SIGNAL STRENGTH]:

Displays the signal strength of received packets.

[LINK QUALITY]:

Displays the overall communication quality with the access point.

| Display        | Communication Status                |
|----------------|-------------------------------------|
| EXCELLENT      | Excellent communication link        |
| GOOD           | ↕                                   |
| FAIR           |                                     |
| POOR           |                                     |
| NOT ASSOCIATED | Poor communication link             |
|                | Not associated with an access point |

[CHANNEL]:

Displays the current communication channel.

Press and hold the **BS/C** key to return to the SITE SURVEY menu.

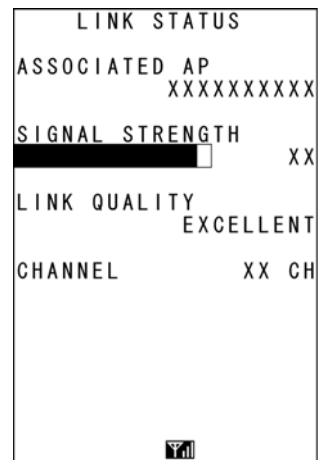

[3] RF Version

1. Select "3: VERSION" at the RF MENU and then press the **ENT** key.

The screen on the right displays after information is acquired.

[V X.XX]: Wireless module firmware version

[MACID]: Wireless module MACID

Press and hold the **BS/C** key to return to the RF MENU.



### 4.5.10 Deleting Program/Data Files (DELETE FILE Menu)

Delete program files or data files stored in the FLASH ROM.

Use the following procedure to delete files.

1. Press the **0** key while holding down the **SF** key at the SYSTEM MENU.

The DELETE FILE menu screen on the right displays.  
Press and hold the **BS/C** key to return to the SYSTEM MENU.

2. Use the cursor keys ([▲] [▼]) to highlight the program to be deleted.

3. Press the **ENT** key.

The screen on the right displays.

**To delete files:**

Use the cursor keys ([▲] [▼]) or numerical key ([1]) to highlight [1: Yes] and then press the **ENT** key.

The selected file is deleted and the screen on the right displays.  
Press and hold the **BS/C** key to return to the DELETE FILE menu.

**To cancel:**

Use the cursor keys ([▲] [▼]) or numerical key ([2]) to highlight [2: No] and then press the **ENT** key.

The screen returns to the DELETE FILE menu.

The screen on the right displays if no files exist.  
Press and hold the **BS/C** key to return to the SYSTEM MENU.

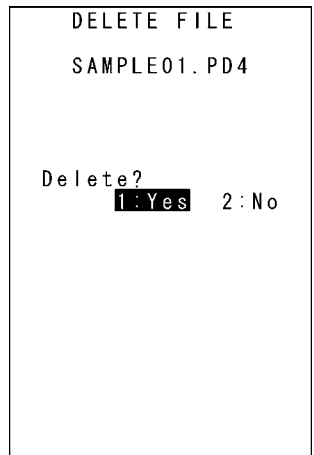
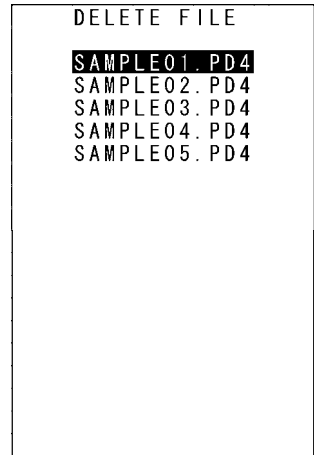

### 4.5.11 Deleting Font Files (DELETE FILE Menu)

Delete font files stored in the FLASH ROM.

If there is insufficient user area, by deleting font files, a user area equal to the size of the deleted font files can be secured.

**Not displaying Japanese fonts at the user program:**

All font files can be deleted.

**Using only 16 dots or 12 dots at the user program:**

Font files that are not used can be deleted.

When deleting font files, upload the font files to the host computer and so on to ensure that they are backed up.

Refer to section “4.5.3 Uploading Files (UPLOAD Menu)” for details of uploading.

Use the following procedure to delete font files.

1. Press the **2** key while holding down the **SF** key at the SYSTEM MENU.

The DELETE FILE menu screen on the right displays.

Press and hold the **BS/C** key to return to the SYSTEM MENU.

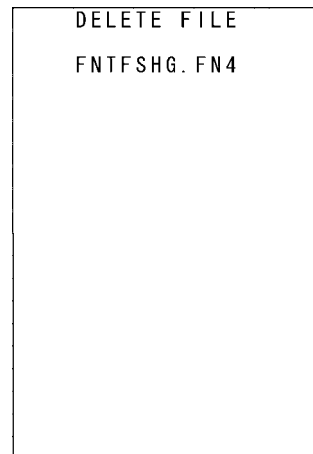

2. Use the cursor keys ([▲] [▼]) to highlight the font file to be deleted.

3. Press the **ENT** key.

The screen on the right displays.

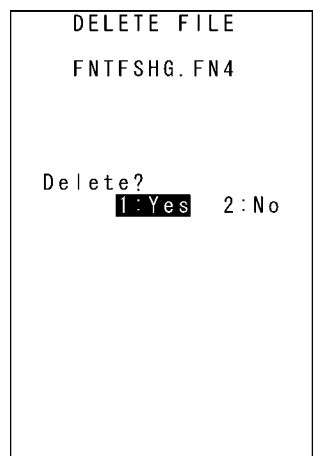

**To delete font files:**

Use the cursor keys ([▲] [▼]) or numerical key ([1]) to highlight [1: Yes] and then press the **ENT** key.

The selected file is deleted and the screen on the right displays.

Press and hold the **BS/C** key to return to the DELETE FILE menu.

**To cancel:**

Use the cursor keys ([▲] [▼]) or numerical key ([2]) to highlight [2: No] and then press the **ENT** key.

The screen returns to the DELETE FILE menu.



The screen on the right displays if no files exist.

Press and hold the **BS/C** key to return to the SYSTEM MENU.

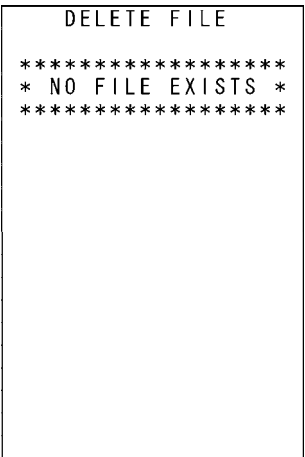

## 4.5.12 Downloading/Uploading the BHT System Parameter File (SYSTEM PARAMETER Menu)

The system parameter file (file name: "\_BHT.SYS") is a file containing settings such as values, LCD contrast and beeper volume set at section "4.5.5 Setting Environment Settings".

The same settings can be set at another BHT by copying the system parameter file to that BHT.

### Copying the System Parameter File

- (1) Upload the system parameter file to the host computer and so on.
- (2) Download the uploaded system parameter file at another BHT.

---

- **Supplement** - The system parameter file can also be copied directly between two BHT units by opening their respective UPLOAD and DOWNLOAD menus.  
Refer to section "4.5.4 Copying Files between 2 BHT Units" for details of the copy method.

---

### ◆ Uploading the System Parameter File

Create a system parameter file based on the current setting values and upload it to the host computer and so on. After uploading, delete the created system parameter file.

### ◆ Downloading the System Parameter File

Receive the system parameter file from the host computer and so on to which it was backed up, and after setting the stored values, delete the received system parameter file.

The communication parameters, communication protocol, and interface set at "[5] Setting the communication environment" in section "4.5.5 System Environment Settings" are used when uploading and downloading.

Use the following procedure to download and upload the system parameter file.

1. Press the **3** key while holding down the **SF** key at the SYSTEM MENU.

The SYSTEM PARAMETER menu screen on the right displays.

[1: DOWNLOAD]:

Downloads the BHT system parameter file to the BHT user area.

[2: UPLOAD]:

Uploads the BHT system parameter file stored in the BHT.

Refer to the following section for details of the above items.

Press and hold the **BS/C** key to return to the SYSTEM MENU.

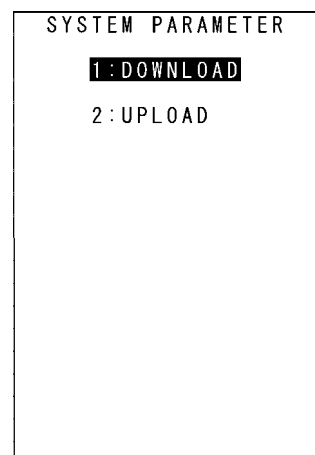

## [1] Downloading the BHT system parameter file

1. Use the cursor keys ([▲] [▼]) or numerical key ([1]) to highlight [1: DOWNLOAD] and then press the **ENT** key.

The screen on the right displays indicating that the BHT is waiting for the system parameter file to be downloaded.

```
DOWNLOAD
** Waiting **
```

2. While the download is in progress, the screen on the right displays indicating the file name and the number of received records/the total number of records.

Press and hold the **BS/C** key to abort the download and return to the SYSTEM PARAMETER menu.

```
DOWNLOAD
  _BHT.SYS
** Loading **
0000000/0000000
```

3. Upon completion of downloading, the BHT displays the screen shown on the right and beeps once.

Press and hold the **BS/C** key to return to the SYSTEM PARAMETER menu.

The beeper sounds three times if an error occurs during downloading, and an error screen displays.

Refer to "Chapter 7 Error Messages" - "7.2 System Mode Errors" and remedy the error.

```
DOWNLOAD
  _BHT.SYS
** Completed **
```

**[2] Uploading the BHT system parameter file**

1. Use the cursor keys ([▲] [▼]) or numerical key ([2]) to highlight [2: UPLOAD] and then press the **ENT** key.

The screen on the right displays indicating that the BHT is waiting for the system parameter file to be uploaded.

```

      UPLOAD
      ** Waiting **
  
```

2. While the upload is in progress, the screen on the right displays indicating the file name and the number of sent records/the total number of records.

Press and hold the **BS/C** key to abort the upload and return to the SYSTEM PARAMETER menu.

```

      UPLOAD
      _BHT.SYS
      ** Loading **
      0000000/0000000
  
```

3. Upon completion of uploading, the BHT displays the screen shown on the right and beeps once.

Press and hold the **BS/C** key to return to the SYSTEM PARAMETER menu.

The beeper sounds three times if an error occurs during uploading, and an error screen displays.

Refer to "Chapter 7 Error Messages" - "7.2 System Mode Errors" and remedy the error.

```

      UPLOAD
      _BHT.SYS
      ** Completed **
  
```



### 4.5.13 Setting the Remote Wake-up (SET REMOTE WAKEUP Menu)

Use the following procedure to perform remote wake-up settings.

1. Press the **4** key while holding down the **SF** key at the SYSTEM MENU.

The SET REMOTE WAKEUP menu displays as shown on the right.

[1: REMOTE WAKEUP]:

Enables or disables remote wake-up.

[2: TRANSMIT SPEED]:

Sets the transmission speed for remote wake-up.

Press and hold the **BS/C** key to return to the SYSTEM MENU.

2. Use the cursor keys ([▲] [▼]) or numerical keys ([1] [2]) to highlight the item to be set.

3. Highlight the settings with the cursor keys ([◀] [▶]) and press the **ENT** key.

Press and hold the **BS/C** key to return to the SYSTEM MENU.

```

SET REMOTE WAKEUP
1: REMOTE WAKEUP
   ON      OFF
2: TRANSMIT SPEED
   9600   19200  38400
  57600  115200  460800
  
```

## 4.5.14 Downloading/Uploading the System Message File (SYSTEM MESSAGE Menu)

The system message file is a file (file name: “\_B50MSG.FN4”) used by the system to display messages such as “Shutdown in progress. Do not remove the battery.” or “Charge the battery!”.

### Downloading/Uploading the System Message File

- (1) Upload the system message file to the host computer and so on.
- (2) Download the uploaded system message file at another BHT.

#### ◆ Uploading the System Message File

Create a system message file based on the current system message settings and upload it to the host computer and so on. After uploading, delete the created system message file.

#### ◆ Downloading the system message file

Receive the system message file from the host computer and so on to which it was backed up, and after setting the stored system messages, delete the received system message file.

The communication parameters, communication protocol, and interface set at “[5] Setting the communication environment” in section “4.5.5 System Environment Settings” are used when uploading and downloading.

---

- **Supplement** · System messages are normally set when the BHT is shipped from the factory, and therefore operation at this menu is unnecessary.

---

Use the following procedure to download and upload the system message file.

### 1. Press the **6** key while holding down the **SF** key at the SYSTEM MENU.

The SYSTEM MESSAGE menu displays as shown on the right.

[1: DOWNLOAD]:

Downloads the system message file.

[2: UPLOAD]:

Uploads the system message file.

Refer to the following section for details of the above items.

Press and hold the **BS/C** key to return to the SYSTEM MENU.

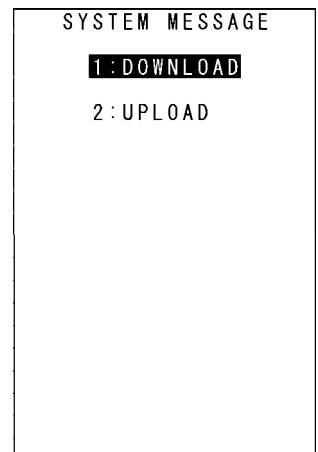

[1] Downloading the system message file

1. Use the cursor keys ([▲] [▼]) or numerical key ([1]) to highlight [1: DOWNLOAD] and then press the **ENT** key.

The screen on the right displays indicating that the BHT is waiting for the system message file to be downloaded.

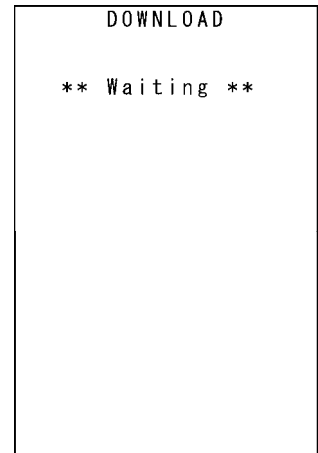

2. While the download is in progress, the screen on the right displays indicating the file name and the number of received records/the total number of records.

Press and hold the **BS/C** key to abort the download and return to the SYSTEM MESSAGE menu.

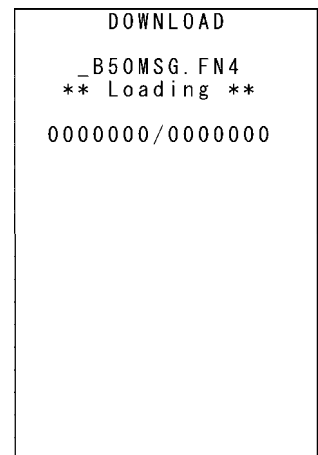

3. Upon completion of downloading, the BHT displays the screen shown on the right and beeps once.

Press and hold the **BS/C** key to return to the SYSTEM PARAMETER menu.

The beeper sounds three times if an error occurs during downloading, and an error screen displays.

Refer to “Chapter 7 Error Messages” - “7.2 System Mode Errors” and remedy the error.

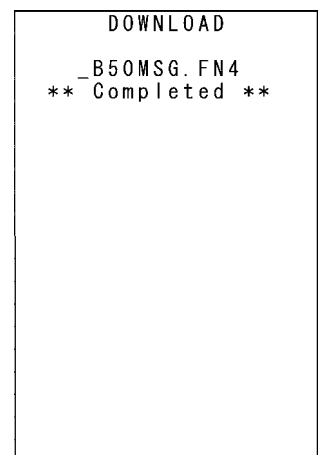

---

- Point - When downloading the system message file, the BHT creates a temporary file named “\_B50MSG.FN4” in the user area. An error will therefore occur if there is insufficient space in the user area to create the temporary file.

The created temporary file will automatically be deleted after downloading is complete.

---

**[2] Uploading the system message file**

1. Use the cursor keys ([▲] [▼]) or numerical key ([2]) to highlight [2: UPLOAD] and then press the **ENT** key.

The screen on the right displays indicating that the BHT is waiting for the system message file to be uploaded.

```

      UPLOAD

      ** Waiting **
  
```

2. While the upload is in progress, the screen on the right displays indicating the file name and the number of sent records/the total number of records.

Press and hold the **BS/C** key to abort the upload and return to the SYSTEM MESSAGE menu.

```

      UPLOAD

      _B50MSG.FN4
      ** Loading **

      0000000/0000000
  
```

3. Upon completion of uploading, the BHT displays the screen shown on the right and beeps once.

Press and hold the **BS/C** key to return to the SYSTEM PARAMETER menu.

```

      DOWNLOAD

      _B50MSG.FN4
      ** Completed **
  
```

The beeper sounds three times if an error occurs during uploading, and an error screen displays.

Refer to "Chapter 7 Error Messages" - "7.2 System Mode Errors" and remedy the error.

---

**- Point -** When uploading the system message file, the BHT creates a temporary file named "\_B50MSG.FN4" in the user area. An error will therefore occur if there is insufficient space in the user area to create the temporary file.

The created temporary file will automatically be deleted after uploading is complete.

---

### 4.5.15 Updating the System (MODIFY MENU)

Use the following procedure to update the system.

1. Press the dot key while holding down the **SF** key at the SYSTEM MENU.

The MODIFY MENU screen on the right displays.

- [1: SYSTEM MODIFY]: Updates the BHT system.
- [2: CU-F/W MODIFY]: Updates the CU-511 system.  
(when equipped with software supporting LAN communication)

Refer to the following section for details of the above items.  
Press and hold the **BS/C** key to return to the SYSTEM MENU.

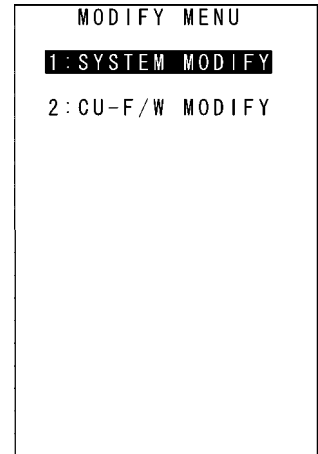

#### [1] Updating the BHT system

Update the BHT system after downloading the BHT system update file.  
(Refer to section "4.2.1 Updating the BHT System" for details.)

1. Use the cursor keys ([▲] [▼]) or numerical key ([1]) to highlight [1: SYSTEM MODIFY] and then press the **ENT** key.

The screen on the right displays.  
If the downloaded BHT update file name differs from this file name, specify the correct file name using the procedure on the following page.

- [1: DO IT]: Updates the BHT system.
- [2: FILENAME]: Displays the filename to be used for updating the BHT system.

Press and hold the **BS/C** key to return to the SYSTEM PARAMETER menu.

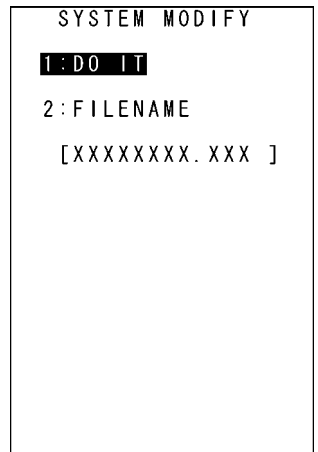

2. Use the cursor keys ([▲] [▼]) or numerical key ([1]) to highlight [1: DO IT] and then press the **ENT** key.

The screen shown on the right displays and the BHT system is updated.  
Upon completion of the update, the BHT power turns OFF automatically.

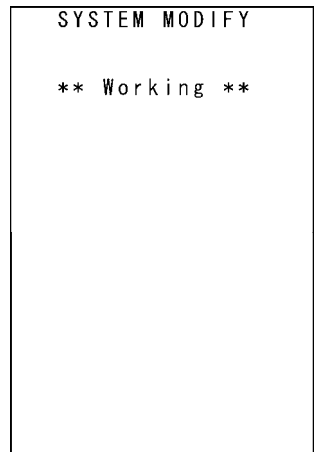

**◆ When the Displayed File Name Differs from the BHT System Update File**

If the name of the file displayed at [2: FILENAME] differs from the name of the BHT system update file to be used for updating the system, enter the correct file name.

1. Use the cursor keys ([▲] [▼]) or numerical key ([2]) to highlight [2: FILENAME] and then press the **ENT** key.

The mode changes to entry mode and the cursor displays.

2. Use the numerical keys and dot key to enter the correct file name.

Press the **SF** key to change the entry mode (numerical entry (no guidance display) and alphabet entry).

To delete a single character, press the **BS/C** key.

Press and hold the **BS/C** key to delete all entries made.

3. Press the **ENT** key to set the entered file name.

**◆ If the System Update File Does not Exist when Updating the BHT System**

The screen on the right displays if the system update file does not exist when updating the BHT system.

Download the BHT system update file and update the BHT system again.

Press and hold the **BS/C** key to return to the MODIFY MENU.

```
SYSTEM MODIFY
*****
* NO FILE EXISTS *
*****
```

**[2] Updating the CU-511 system (when equipped with software supporting LAN communication)**

Update the CU-511 system after downloading the CU-511 system update file.  
(Refer to section "4.2.2 CU-511 System Update (when Equipped with LAN Communication Software)" for details.)

- 1.** Use the cursor keys ([▲] [▼]) or numerical key ([2]) to highlight [2: CU-F/W MODIFY] and then press the **ENT** key.

The CU-F/W MODIFY menu screen on the right displays.

[1: DO IT]:

Updates the CU-511 system.

[2: FILENAME]:

Displays the filename to be used for updating the CU-511 system.

[TRANSMIT SPEED]

Select 460800(bps).

Press and hold the **BS/C** key to return to the SYSTEM PARAMETER menu.

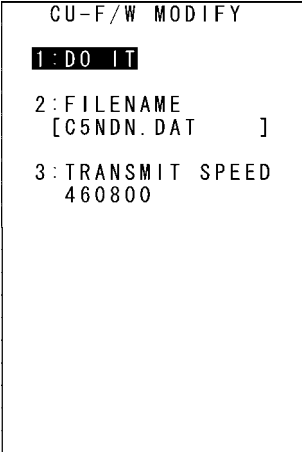

- 2.** Use the cursor keys ([▲] [▼]) or numerical key ([1]) to highlight [1: DO IT] and then press the **ENT** key.

The screen shown on the right displays and the CU-511 system is updated.  
The screen on the right displays upon completion of the update.

Press and hold the **BS/C** key to return to the CU-F/W MODIFY menu.

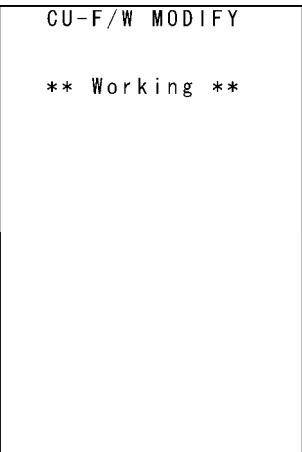

◆ **When the Displayed File Name Differs from the CU-511 System Update File**

If the name of the file displayed at [2: FILENAME] differs from the name of the CU-511 system update file to be used for updating the system, enter the correct file name.

- 1.** Use the cursor keys ([▲] [▼]) or numerical key ([2]) to highlight [2: FILENAME] and then press the **ENT** key.

The mode changes to entry mode and the cursor displays.

- 2.** Use the numerical keys and dot key to enter the correct file name.

Press the **SF** key to change the entry mode (numerical entry (no guidance display) and alphabet entry).

To delete a single character, press the **BS/C** key.

Press and hold the **BS/C** key to delete all entries made.

- 3.** Press the **ENT** key to set the entered file name.

◆ **If the System Update File Does not Exist when Updating the CU-511 System**

The screen on the right displays if the system update file does not exist when updating the CU-511 system.

Download the CU-511 system update file and update the CU-511 system again.

Press and hold the **BS/C** key to return to the CU-F/W MODIFY menu.

```
CU-F/W MODIFY
*****
* NO FILE EXISTS *
*****
```

◆ **If the BHT Has not been Set on the CU-511 when Updating the CU-511 System**

The screen on the right displays if the BHT has not been set on the CU-511 when updating the CU-511 system.

Set the BHT on the CU-511 and try again.

Press and hold the **BS/C** key to return to the CU-F/W MODIFY menu.

```
CU-F/W MODIFY

This BHT is not set
on the CU.
```

◆ **If the CU-511 System Update Fails**

The screen on the right displays if the CU-511 system update fails.

Ensure that the BHT has been set properly on the CU-511 and then try again.

Press and hold the **BS/C** key to return to the CU-F/W MODIFY menu.

```
CU-F/W MODIFY
*****
* MODIFY ERROR *
*****
```



Outline

BHT Preparation

Basic Operation

**System Operation**

Communication

Maintenance

Error Messages

Specifications

Appendices

## **Chapter 5**

# **Communication**

This chapter describes technical information relating to the connector communication (RS-232C interface), infrared communication, and wireless communication functions with which the BHT is equipped.

|       |  |     |
|-------|--|-----|
| 5.1   | Connector Communication(RS-232C Interface) .....               | 154 |
| 5.1.1 | Interface Connector and Pin Assignment .....                   | 154 |
| 5.1.2 | Interface Cable Connection .....                               | 155 |
| 5.2   | Infrared Communication .....                                   | 156 |
| 5.2.1 | Infrared Communication Port Baud Rate.....                     | 157 |
| 5.2.2 | BHT Hardware (Physical Layer) and Communication Protocols..... | 157 |
| 5.3   | Wireless Communication .....                                   | 158 |
| 5.3.1 | Usage Precautions .....  | 158 |
| 5.3.2 | Setting Parameters .....                                       | 159 |
| 5.4   | Basic Communication Specifications and Parameters.....         | 161 |
| 5.4.1 | Basic Communication Specifications .....                       | 161 |
| 5.4.2 | Communications Parameters.....                                 | 163 |

## 5.1 Connector Communication(RS-232C Interface)

The BHT-500B is equipped with a connector interface used to communicate with other devices.

### 5.1.1 Interface Connector and Pin Assignment

Connector interface : JC-25-J-3A (ø2.5 mm stereo mini jack)

Connector pin: JC-25-P3 (ø2.5 mm stereo mini plug)

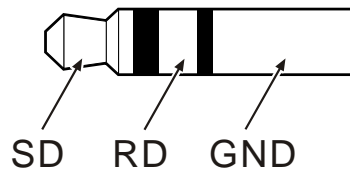

| Signal Name | Function      | Signal Input/Output |                 |
|-------------|---------------|---------------------|-----------------|
|             |               | BHT                 | External device |
| SD          | Send data     | →                   |                 |
| RD          | Receive data  | ←                   |                 |
| SG          | Signal ground | —                   |                 |

#### Signal Voltage Input/Output Level

| Signal | Input Voltage Threshold (RD) | Output Voltage Threshold (SD) |
|--------|------------------------------|-------------------------------|
| 0      | 3V min.                      | 5V min.                       |
| 1      | -3V max                      | -5V max.                      |

- Note –
- The BHT connector port is not designed for frequent cable insertion and removal. Repeatedly inserting and removing the cable more than once a day will result in a shortening of the connector port lifetime, and therefore infrared communication (CU-500 Series, IrDA device etc.) should normally be used.
  - Allow the specified signals only to enter the connector interface port. Entry of other signals will result in a failure or malfunction of the BHT.

### 5.1.2 Interface Cable Connection

Connect the BHT directly to a host computer, a modem, or a printer with a connector interface cable as illustrated below.

[Ex.1] Cable Connection between BHT and Host computer

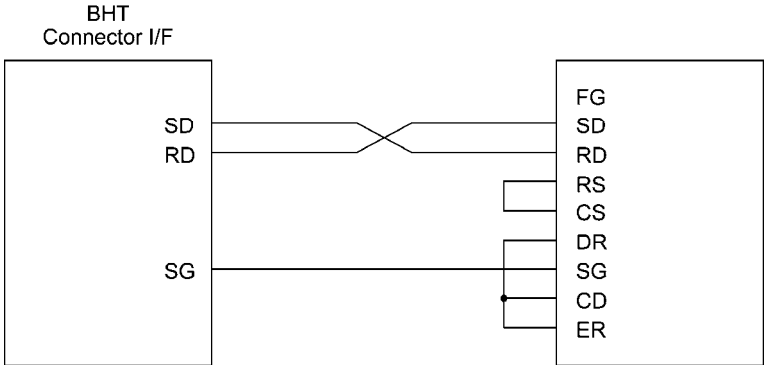

[Ex.2] Cable Connection between BHT and Modem

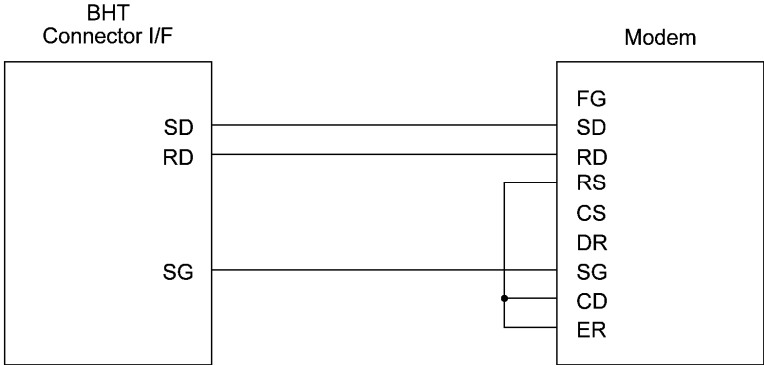

[Ex.3] Cable Connection between BHT and Printer

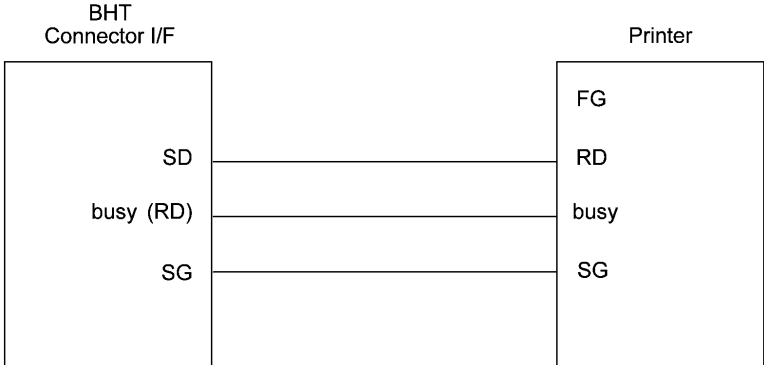

## 5.2 Infrared Communication

The BHT has a built-in infrared communication device that enables wireless transfer of programs and data both between the BHT and the host computer and between BHTs without the need for a cable.

Infrared communication offers the following benefits over other forms of communication.

- Communication without the need for a cable
- Small and lightweight design
- High communication speed
- Freedom from regulations and licenses that differ from country to country when using wireless devices

Communication is performed by arranging the BHT and other IrDA-compliant devices with their IrDA (infrared) interface ports facing one another. The communication distance and angle and so on will differ depending on the devices used. Refer to the instructions given in the manuals provided with such equipment.

---

– **Point** – When communication is not possible, move the respective devices closer together or change the angle of the IrDA interface ports and try again.

---

## 5.2.1 Infrared Communication Port Baud Rate

| Communicating Device | Baud Rate                               |
|----------------------|---|
| BHT-500 シリーズ         | 9.6, 19.2, 38.4, 57.6, 115.2, 460.8kbps |
| CU-501               | 9.6, 19.2, 38.4, 57.6, 115.2kbps        |
| CU-511               | 460.8kbps                               |
| CU-521               | 115.2, 460.8kbps                        |

## 5.2.2 BHT Hardware (Physical Layer) and Communication Protocols

### ◆ BHT Hardware (Physical Layer) (Max. Baud Rate: 115.2 kbps)

The BHT complies with IrDA Ver1.2 Low Power physical layer compliant by IrDA (Infrared Data Association). The maximum transmission distance is 0.15 m.

### ◆ BHT Communication Protocols

The BHT supports Ymodem, BHT-Ir protocol, and BHT protocol.

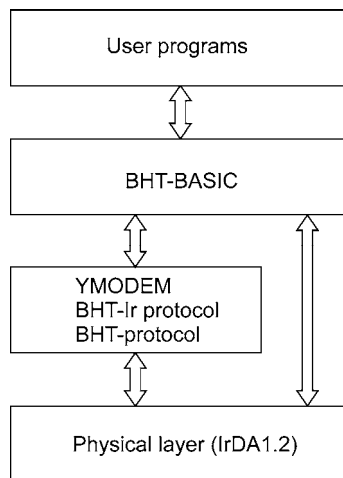

## 5.3 Wireless Communication

The BHT-504BW is equipped with a 2.4 GHz waveband wireless module.

### 5.3.1 Usage Precautions

- It may be possible to avoid the easy occurrence of communication errors by pointing the right side of the BHT (equipped with built-in antenna) toward the access point. This is because the radio waves of the 2.4 GHz waveband on which the BHT operates are emitted straight ahead and do not easily pass through the human body and so on.
- Communication may not be possible when used in the vicinity of wireless devices, microwave ovens, industrial heating equipment or high-frequency medical equipment operating on the same 2.4 GHz waveband as the BHT.
- Communication may not be possible due to electromagnetic noise when the BHT is used in the vicinity of household appliances such as computers or refrigerators.
- Communication may not be possible in the following locations.
  - In the vicinity of metal objects or in places with high levels of metallic dust
  - Rooms surrounded by metal walls
  - Places subject to strong impact

– Point –

#### Requests to System Designers

- Communication may not be possible depending on the environment in which the device is being used. Ensure that problem-free communication is possible prior to use.
- Use a program capable of retransmitting data if communication fails.
- If the BHT is introduced into an environment in which a device using 2.4 GHz waveband electromagnetic waves is operating, or if another device using 2.4 GHz waveband electromagnetic waves is introduced following introduction of the system, run all devices and ensure that communication with the BHT is possible prior to use.
- Check communication once again prior to use if any changes are made to the usage environment (addition of household appliances, movement or addition of shelves, equipment and so on) following introduction of the system.

– Point –

#### Wireless LAN Interference

In addition to industrial, scientific, and medical equipment such as microwave ovens, static wireless stations (permit required) used for mobile identification in places such as plant manufacturing lines, amateur wireless stations, and specified low-power wireless stations (no permit required) operate on the same frequency band as this device.

1. Before using this device, ensure that no static wireless stations or specified low-power wireless stations for mobile identification are being used in the vicinity.
2. In the event of instances of electromagnetic interference from this device to a static wireless station being used for mobile identification, either promptly alter the usage frequency, or halt the electromagnetic discharge.
3. If other problems arise due to reasons such as electromagnetic interference from this device to a specified low-power wireless station being used for mobile identification, please contact DENSO WAVE through QBdirect (see page ii).

### 5.3.2 Setting Parameters

Programs written in BHT-BASIC control wireless communication with commands between the BHT and access points which are connected each other by a wireless LAN.

For the setting procedure of RF-related parameters, refer to “Chapter 4 System Operation” – “Wireless Communication Settings (RF MENU).”

#### ◆ Service Set ID (SSID)

SSID is an ID to be used on the communications network. The BHT is able to communicate with devices having the same SSID.

The SSID of the BHT should be the same as that of the access point you want to use.

#### ◆ POWER SAVE

You may place the wireless module built in the BHT in the energy saving mode.

If this mode is set to “OFF,” the service period of the BHT may be shortened.

If it is set to ON, the BHT may take more time to wake-up for link operation or send response messages.

#### ◆ RADIO MODE

Setting the Wireless Method

Select either 11b (802.11b) or 11g (802.11g) based on the access point setting.

Please note that 11g should be selected when 11b/11g auto.

#### ◆ WEP (Wired Equivalent Privacy)

When WEP is ON, messages to be sent/received over the wireless LAN will be encrypted.

The WEP KEY uses 40-bit (10-digit hexadecimal) or 128-bit (26-digit hexadecimal) encryption word.

The BHT is able to definitely communicate with the access points having the same WEP KEY.

#### ◆ WEP KEY

You can set four types of encryption keys (WEP KEY1 through WEP KEY4).

If you enable WEP, choose any one of WEP KEY1 through WEP KEY4 as TRANSMIT KEY.

#### ◆ AUTHENTICATE

This is the authentication method setting employed when using encrypted communication (WEP setting), and a selection can be made from OPEN or SHAREDKEY.

Select OPEN when the WEP setting is OFF. Communication will no longer be possible if OPEN is not selected.

#### ◆ TRANSMIT KEY

You need to use the TRANSMIT KEY in order to choose and activate any one of the WEP KEY1 through WEP KEY4 already defined.

#### ◆ SECURITY MODE

This is the setting for the wireless security function.

A selection can be made from no security (WEP level), 1x Supplicant, WPA-1x or WPA-PSK.

WPA2-1x and WPA2-PSK can also be selected when equipped with WPA2 compliant software.



**◆ EAP TYPE**

This is the EAP authentication method setting used for 802.1x authentication.

Select PEAP or EAP-TLS.

This is valid only when the Security mode is 1x Supplicant, WPA-1x or WPA2-1x.

**◆ IDENTITY**

This is the user ID used for 802.1x authentication.

A format that includes the domain name (<domain name>\<user name>) may be specified for the identity.

An identity, including the domain name, may be specified up to 32 bytes. The domain name may be omitted.

**◆ PASSWORD**

This is the password used for 802.1x authentication.

This is valid only when the EAP TYPE is PEAP.

**◆ ROOT CERTIFICATE**

This setting is for the filename of the root certificate used for 802.1x authentication.

**◆ CLIENT CERTIFICATE**

This setting is for the filename of the client certificate used for EAP-TLS authentication.

**◆ ANONYMOUS IDENTITY**

This is the setting for the ID transmitted by EAP Request (ID) packet when performing PEAP authentication.

**◆ WPA CIPHER**

This is the setting for the encryption method used when specifying WPA.

Select TKIP or AES. (when equipped with WPA2 compliant software)

**◆ PRE SHARED KEY**

This is the setting for the key used for WPA-PSK or WPA2-PSK.

Always set when the Security mode is WPA-PSK or WPA2-PSK.

## 5.4 Basic Communication Specifications and Parameters

### 5.4.1 Basic Communication Specifications

The table below lists communication specifications when the BHT exchanges data with the host computer using the IrDA interface or connector interface.

|                        | IrDA Interface                                      | Connector Interface   |
|------------------------|---|---|
| Synchronization        |   | Start-stop  |
| Transmission speed     | 9600, 19200, 38400,<br>57600, 115200 or 460800* bps | 300, 600, 1200, 2400,<br>4800, 9600, 19200,<br>38400, 57600, 115200 bps |
| Transmission code      | ASCII 8-bit code                                    | ASCII 7-bit or 8-bit code   |
| Transmission bit order |   | LSB (Least significant bit) first                                       |
| Vertical parity        | None  | Even, odd, or none  |

\* 460800bps is only possible when communicating from one BHT-500B unit to another or between the BHT-500B and CU-521 or BHT-500B and CU-511.

#### ◆ Synchronization

For accurate data transaction, it is necessary to synchronize transmission between the sender and receiver. To achieve this, the bit order and position, character length, and beginning and end of the character to be transmitted must be defined beforehand.

Start-stop synchronization is an asynchronous system that synchronizes each character as a unit; that is, it externally adds start and stop bits to the leading and trailing bit positions of the character to be transmitted, respectively. Data sampling is commenced upon receiving the start bit, and when the stop bit is received, sampling is completed and communication ceased. The number of stop bits can be selected (1 or 2 bits).

#### ◆ Transmission Speed

This is the maximum number of bits that can be transmitted per second, and is expressed in bps (bits per second).

#### ◆ IrDA Interface Communication Range

The maximum effective range of the IrDA interface is 15 cm, with the IR beam within a 10° angle of divergence.

To communicate via the CU-500, put the BHT on the CU-500.

#### ◆ IrDA Interface Transmission/Receipt Switching Time

The IrDA interface must satisfy the following conditions for transmission and receipt switching.

- (1) The IrDA interface must be ready to receive within 10 ms following the completion of transmission.
- (2) The IrDA interface must commence transmission after waiting at least 10 ms following the completion of receipt.

◆ **Transmission Code and Bit Order**

- All characters should be coded to 7 or 8-bit code for data transmission.
- The standard code at the BHT is ASCII 7-bit or 8-bit code.
- The transmission bit order is LSB (Least significant bit) first.

The example below is for the transmission of an ASCII 8-bit code A (41h or 01000001b, b: binary) with even vertical parity and a single bit each for the start and stop bits.

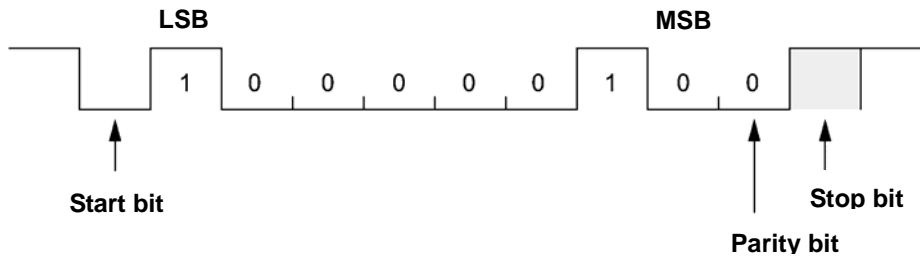

◆ **Vertical Parity**

A vertical parity bit is a redundant bit that is added to every character transmitted in order to check that data has been transmitted accurately. The parity bit should be set to either "1" or "0" depending upon the parity parameter setting to make the number of set bits in the character even or odd. The receiver counts the number of set bits in the transmitted character code to make sure that it has the specified number (even or odd) of set bits.

The vertical parity bit is positioned immediately after the MSB (Most significant bit) as shown below.

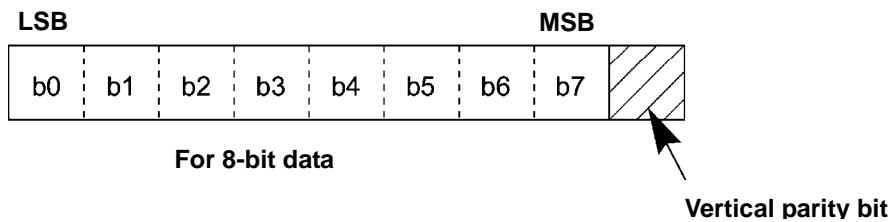
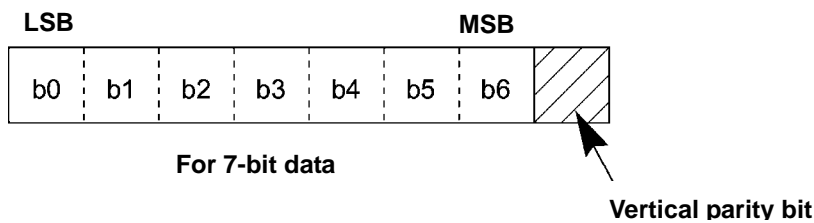

## 5.4.2 Communications Parameters

In System Mode and user programs written in BHT-BASIC, you can set the communications parameters listed below.

| Port               | IrDA Interface                                      | Connector Interface   |
|--------------------|---|---|
| Transmission speed | 9600, 19200, 38400,<br>57600, 115200 or 460800* bps | 300, 600, 1200, 2400,<br>4800, 9600, 19200,<br>38400, 57600 or 115200 bps |
| Character length   | 8 bits  | 7 or 8 bits   |
| Vertical parity    | None  | Even, odd, or none  |
| Stop bit length    | 1 bit   | 1 or 2 bits   |

\* 460800bps is only possible when communicating from one BHT-500B unit to another or between the BHT-500B and CU-521 or BHT-500B and CU-511.

### ◆ System Mode

Refer to “Chapter 4 System Operation” – “4.4.3 System Properties.”

### ◆ BHT-BASIC

To set the transmission speed, character length, vertical parity, and stop bit length (For the IrDA interface, set the transmission speed only), use the OPEN “COM:” statement in BHT-BASIC.

OPEN “COM: ... “ Opens the interface port selected in System Mode.

OPEN “COM1: ... “ Opens the IrDA interface port for data transmission, irrespective of the setting in System Mode.

OPEN “COM2: ... “ Opens the direct-connect interface port for data transmission, irrespective of the setting in System Mode.

Note that it is impossible to open both the IrDA and connector interface ports concurrently.

Through the interface port opened by the OPEN “COM:” statement, the *XFILE* statement transmits a designated file.

Outline

BHT Preparation

Basic Operation

System Operation

**Communication**

Maintenance

Error Messages

Specifications

Appendices

**BHT-500B**

## **Chapter 6**

# **Maintenance**

This chapter describes battery cartridge and daily procedures for taking care of the BHT and CU/CH.

|       |  |     |
|-------|--|-----|
| 6.1   | Replacing the Battery Cartridge.....       | 166 |
| 6.1.1 | Battery Cartridge Service Life.....        | 166 |
| 6.1.2 | Battery Cartridge Replacement Method ..... | 166 |
| 6.2   | Using the BHT after Long Periods .....     | 168 |
| 6.3   | Daily Maintenance .....                    | 169 |
| 6.3.1 | Proper Care of the BHT .....               | 169 |
| 6.3.2 | Proper Care of the CU/CH .....             | 169 |

## 6.1 Replacing the Battery Cartridge

### 6.1.1 Battery Cartridge Service Life

The battery cartridge is a consumable part and should be replaced after being charged approximately 300 times.

The performance of the battery cartridge's lithium-ion battery will deteriorate gradually with repeated charging, even during normal use. When the battery operation time becomes shorter even after charging for the specified length of time, replace the battery with a new one.

### 6.1.2 Battery Cartridge Replacement Method

1. Press the **power** key (  ) to turn OFF the BHT power.

The screen on the right displays.

---

- **Point** - Do not remove the battery cartridge until the power turns OFF and the screen display clears.

---

Shutdown  
in progress.  
  
Do not remove the  
battery.

2. Slide the battery cover lock (1) in the direction shown by the arrow, remove the battery cover (2), and then remove the battery cartridge (3).

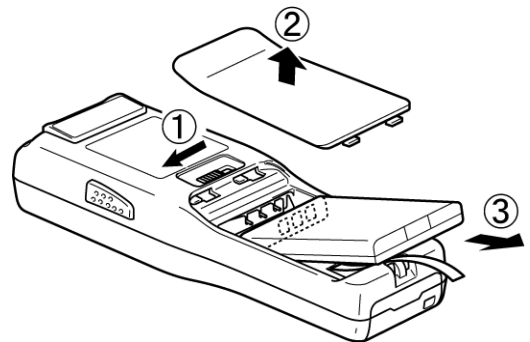

3. Check the terminals on the new battery cartridge and then insert in the direction shown by the arrow.

(Refer to "Chapter 2 BHT Preparation" – "2.2 Loading and Charging the Battery Cartridge".)

---

- **Point** - Insert the new battery cartridge within 3 minutes of removal to avoid data loss.

---

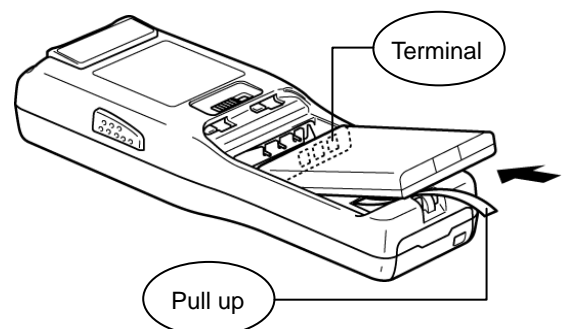

4. Close the battery cartridge cover (1) and return the battery cover lock (2).

– Point – Ensure that the battery pull strap is not jammed by the cover.

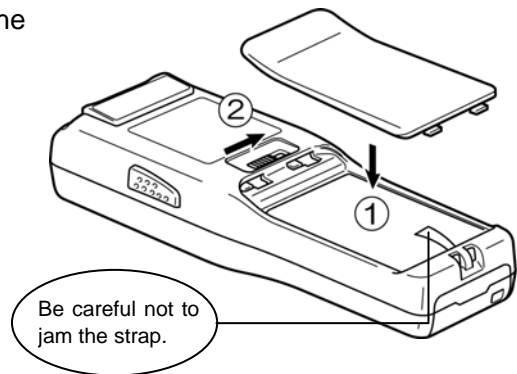

#### Battery Cartridge Recycling Request

- This product uses a lithium-ion battery that contains scarce, recyclable resources. We kindly ask for your cooperation in recycling to ensure reuse of these resources.



The crossed-out wheeled bin is applicable for EU member status only.

- Used battery cartridges must not be disposed of as combustibles.
- Contact your nearest rechargeable battery recycling centre or local sales office for information on disposal procedures.
- When disposing of used battery cartridges at your nearest recycle centre, cover the terminals with vinyl tape to insulate and protect from overheating or fire due to a short-circuit.
- Never disassemble battery cartridges.

#### ⚠ WARNING

Mishandling may result in battery cartridge overheating, smoke generation, blowout or combustion. Please read the following items prior to use.

- Never charge the battery cartridge in the vicinity of fire or under a scorching sun.
- Always use a dedicated charger to charge the battery cartridge.

#### ⚠ CAUTION

Mishandling may result in battery cartridge overheating, smoke generation, blowout or combustion. Please read the following item prior to use.

- Terminate charging if not completed even after the specified time has elapsed.

#### – Note –

- Replace the battery cartridge promptly.
- Always turn the BHT power OFF before replacing the battery cartridge. Replace the depleted battery cartridge with a new one within three minutes to avoid data loss. Following replacement, turn ON the BHT power and check operation.
- The battery cartridge is charged using either a CU-501/521/511 communication unit (option) or CH-551/501 battery charger (option). Refer to the respective User's Manual provided with each device for details of the charging method for the CH-551/CH-501.
- If a "Battery voltage has lowered." or "Replace or recharge the battery cartridge." message displays when impact is applied to the BHT, reboot the BHT and check the battery voltage level. The battery may not actually be depleted.



## 6.2 Using the BHT after Long Periods

Data stored in the BHT may be lost and the calendar clock may stop if the BHT is left unused for long periods of time. Take appropriate measures in accordance with the procedure below.

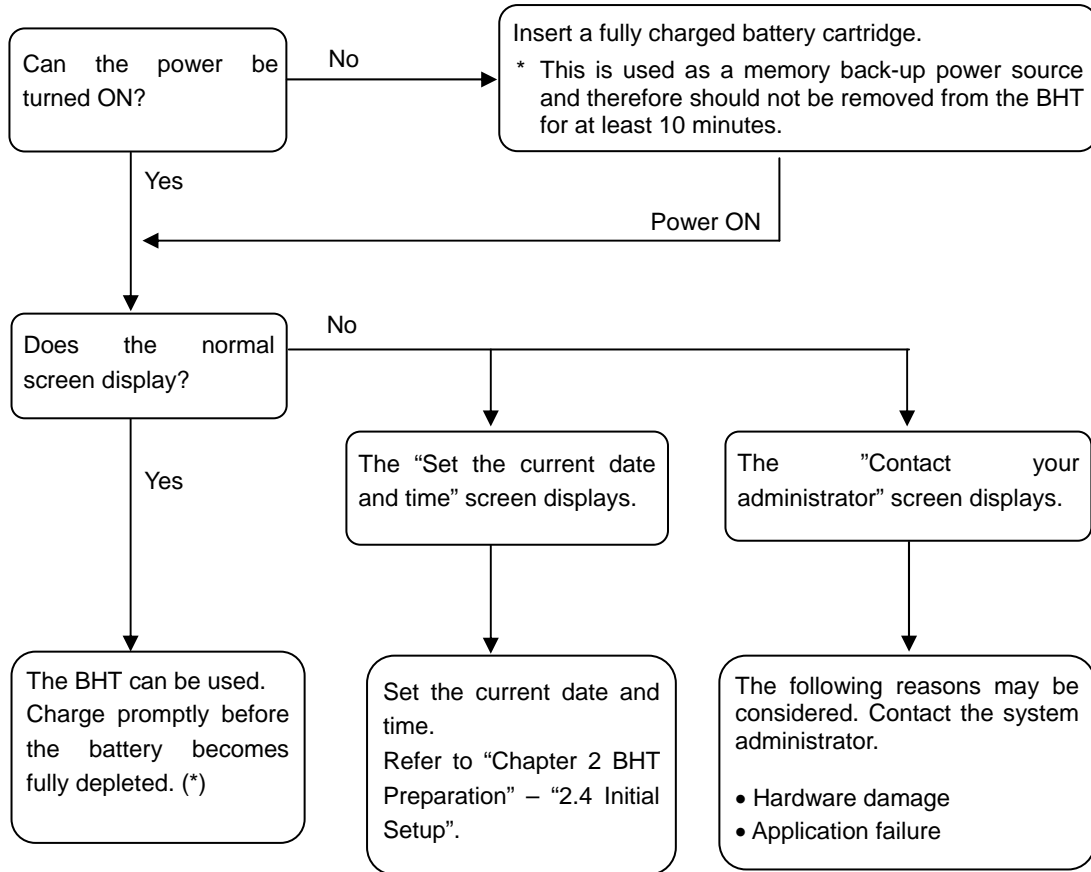

---

- Point - \*: Files may become corrupt if left for a long period of time without replacing the battery cartridge.

---

## 6.3 Daily Maintenance

### 6.3.1 Proper Care of the BHT

Wipe any dirt from the BHT housing, charge terminals, and BHT or battery cartridge terminals with a dry, soft cloth. Ensure to turn OFF the BHT before cleaning.



- Note –
- Never use substances such as benzene or alcohol, as this may cause the housing to be marred or paint to peel off.
  - Never rub or strike the LCD screen with anything hard, as this may result in scratches on the screen or breakage.
  - When cleaning the keypad, do not scrub the surface too hard or pull on the keys, as this may break the keys.
  - If excessively dirty, wipe with a soft cloth that has been soaked in soapy water (always use neutral detergent) and wrung out thoroughly.

Any dirt or dust adhering to the clear plate of the barcode reading window will adversely affect reading performance.

When using in dusty areas, perform periodic inspections to check whether any dust has accumulated on the clear plate of the barcode reading window, and if so, clean the plate as described below.

- First blow the dust away with an airbrush, and then gently wipe the plate with a cotton swab or similar soft object.
- If sand or hard particles have accumulated, rubbing the plate will result in scratches. Blow the particles away with an airbrush or wipe with a soft brush.

### 6.3.2 Proper Care of the CU/CH

Wipe any dirt from the housing or charge terminals with a dry, soft cloth.

In the interests of safety, unplug the AC adapter from the socket when cleaning the CU or CH.

Outline

BHT Preparation

Basic Operation

System Operation

Communication

**Maintenance**

Error Messages

Specifications

Appendices

**BHT-500B**

## **Chapter 7**

# **Error Messages**

This chapter describes causes and countermeasures for error messages that display during BHT use.

Refer to the programming manual appendix A “Error Codes and Error Messages” for the errors while the application is running.

|     |                         |     |
|-----|-------------------------|-----|
| 7.1 | System Errors.....      | 172 |
| 7.2 | System Mode Errors..... | 176 |

# 7.1 System Errors

The error messages that display on the screen and the causes and countermeasures to be taken if an error occurs when the power is turned ON or while running a program are shown below.

| Message   | BHT Response  | Cause   | Countermeasure                                    |
|---|---|---|---|
| <pre>***** ** No System! ** *****</pre>   | <p>If this error occurs, the BHT beeps five times and then turns itself off.</p>  | <p>A System Program error has occurred.</p>                                     | <p>Contact your system administrator.</p>         |
| <pre>Battery voltage has lowered.</pre>   | <p>If low battery is detected, the BHT beeps three times. After that, it will resume previous regular operation.</p>  | <p>The battery output level has dropped below a specified lower limit.</p>      | <p>Replace or recharge the battery cartridge.</p> |
| <pre>Battery voltage has lowered.  Replace or recharge the battery cartridge.</pre> | <p>If lower battery is detected, the BHT beeps five times and then turns itself off. Depending upon the battery level, the beeper may not sound five times.</p> | <p>The battery output level has lowered so that the BHT no longer operates.</p> | <p>Replace or recharge the battery cartridge.</p> |

| Message  | BHT Response  | Cause  | Countermeasure   |
|--|---|--|--|
| <p>Set the current date and time.</p> <p>00/01/01 00:00<br/>_ / / :</p>  | The date and time settings screen displays, awaiting entry. | The calendar clock integrated in the BHT has stopped because: <ul style="list-style-type: none"> <li>- the battery cartridge had been removed for a long time,</li> <li>- the battery cartridge had not been recharged for a long time.</li> </ul> | Set the current date and time.(Refer to “Chapter 2 BHT Preparation” – “2.4 Initial Setup”)   |
| <p>Your terminal was not shut down properly the last time it was used.</p> <p>Unsaved data was lost.</p> <p>[SF+2]</p> | The message continues to display.                           | After shut down abnormally, the BHT has been left without the battery cartridge loaded, or with discharged battery cartridge loaded, so unsaved data was lost.   | Contact your system administrator.   |
| <p>Reload the battery to restart!</p> <p>XXXXXXXX 01</p>   | If this error occurs, the BHT beeps five times.             | During execution of System Program, the System Program has attempted to write onto the write-protected area of the memory.<br>(xxxxxxx: Error address)   | Unload and reload the battery cartridge, then turn the BHT on.<br>If this error occurs frequently, make a note of the displayed message and codes and contact your system administrator. |
| <p>Reload the battery to restart!</p> <p>tskid:XXXXXXXX<br/>erod:XXXXXXXX<br/>addr:XXXXXXXX 02</p>                     | If this error occurs, the BHT beeps five times.             | During execution of System Program, the System Program has received an invalid command code.<br>(xxxxxxx: Error address)   |  |

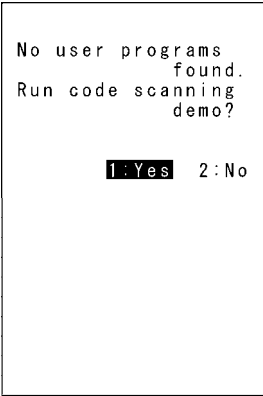
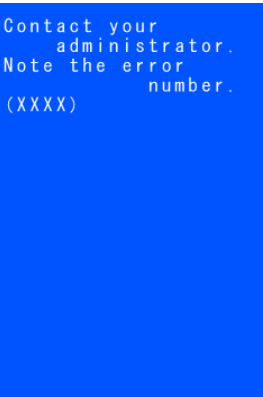
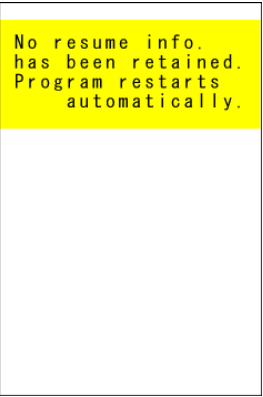
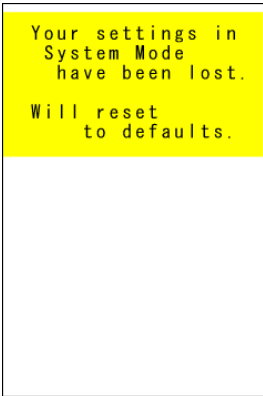
| Message   | BHT Response   | Cause  | Countermeasure   |
|---|--|--|--|
|  <p>No user programs found.<br/>Run code scanning demo?<br/>1:Yes 2:No</p>         | The message continues to display.  | When the BHT is turned on, no user programs are found.   | Contact your system administrator.<br>You can run the code scanning demo without user programs.<br>Pressing "1:Yes" runs the code scanning demo. Press the trigger switch to start the code scanning demo. Selecting "2:No" turns the power off. |
|  <p>Contact your administrator.<br/>Note the error number.<br/>(XXXX)</p>         | If this error occurs, the BHT beeps five times and then turns itself off.  | Any of the hardware error, memory error and execution program error has occurred. (XXXX: Error code)                                   | Turn the BHT on again. If this error occurs frequently, make a note of the displayed code and contact your system administrator.   |
|  <p>No resume info. has been retained.<br/>Program restarts automatically.</p>   | The BHT displays this error message and automatically runs the execution program from the point of start-up.   | Operation was terminated without turning OFF the power normally with the resume function set, and therefore resume info has been lost. | If this error occurs frequently, make a note of the displayed code and contact your system administrator.  |
|  <p>Your settings in System Mode have been lost.<br/>Will reset to defaults.</p> | After displaying this error message, the BHT may start a user program other than the preset auto-start execution program or display the message "No execution program loaded." | Your settings made in System Mode contain an error.  | Contact your system administrator.<br>(If this error occurs, the System Mode settings revert to the factory defaults.)   |

| Message   | BHT Response   | Cause  | Countermeasure  |
|---|--|--|---|
|  | <p>If this error occurs, the BHT beeps five times.</p> | <p>An error has occurred during execution of System Program.</p> | <p>Unload and reload the battery cartridge, then turn the BHT on.<br/>If this error occurs frequently, make a note of the displayed code and contact your system administrator.</p> |



## 7.2 System Mode Errors

When error messages display while running System Mode, refer to the following table and take appropriate measures.

| Message   | BHT Response  | Countermeasure   |
|---|---|--|
| <pre>EXECUTE PROGRAM  ***** * NO FILE EXISTS * *****</pre>                  | <p>You attempted to execute a user program in the EXECUTE PROGRAM menu, but no user program files had been stored in the memory.</p>  | <p>Press the <b>BS/C</b> key for at least 0.5 seconds to return to the SYSTEM MENU, then download user programs.</p>   |
| <pre>DOWNLOAD FILE  XXXXXXXXX.XXX Out of memory  Retry?   1:Yes  2:No</pre> | <p>The memory is insufficient for storing files to be downloaded.</p>   | <p>Press the <b>2</b> key to return to the SYSTEM MENU, then delete unnecessary files in the memory or decrease the size of the file to be downloaded.</p>                           |
| <pre>DOWNLOAD  XXXXXXXXX.XXX File mismatch  Retry?   1:Yes  2:No</pre>      | <p>In the SYSTEM PARAMETER transfer menu, you attempted to download a file other than the BHT system parameter file. Or in the SYSTEM MESSAGE transfer menu, you attempted to download a file other than the system message file.</p> | <p>Check the file you attempted to download and then download the file in the appropriate menu (DOWNLOAD menu, SYSTEM PARAMETER transfer menu, or SYSTEM MESSAGE transfer menu).</p> |

| Message   | BHT Response   | Countermeasure  |
|---|--|---|
| <pre> DOWNLOAD FILE XXXXXXXXX.XXX Too many files  Retry? 1:Yes 2:No </pre>      | <p>The current download will exceed the maximum allowable number of files (120 files) in the memory.</p> | <p>Press the <b>2</b> key to return to the SYSTEM MENU, then delete unnecessary files in the memory (or decrease the number of files to be downloaded if you attempted to download more than one file in the DOWNLOAD menu.)</p>  |
| <pre> DOWNLOAD FILE XXXXXXXXX.XXX Communication error  Retry? 1:Yes 2:No </pre> | <p>Downloading has failed.<br/>Uploading has failed.</p>   | <p>To retry downloading/uploading, press the <b>1</b> key.<br/>To return to the SYSTEM MENU, press the <b>2</b> key. Check the interface port, communications parameters, and communications protocol in the SET SYSTEM menu or perform the communications test in the TEST menu.</p> |
| <pre> DOWNLOAD FILE XXXXXXXXX.XXX Program file error  Retry? 1:Yes 2:No </pre>  | <p>You attempted to download an invalid program file.</p>  | <p>Check whether the program file you attempted to download is available to the BHT-500 model. If it is not available, download the appropriate program.</p>  |
| <pre> UPLOAD FILE  File error  Upload? 1:Yes 2:No </pre>                        | <p>The file you attempted to upload is damaged.</p>  | <p>To upload the damaged file as is, press the <b>1</b> key.</p>  |

| Message  | BHT Response   | Countermeasure  |
|--|--|---|
| <div style="border: 1px solid black; padding: 10px; text-align: center;"> <p>UPLOAD</p> <p>Out of memory</p> </div>  | <p>The memory is insufficient for setting up the BHT system parameter file or system message file to be uploaded.</p>        | <p>Press the <b>BS/C</b> key to return to the SYSTEM MENU and delete unnecessary files.</p> |
| <div style="border: 1px solid black; padding: 10px; text-align: center;"> <p>UPLOAD</p> <p>Too many files</p> </div> | <p>The memory has already contained 120 files, so the BHT system parameter file or system message file cannot be set up.</p> | <p>Press the <b>BS/C</b> key to return to the SYSTEM MENU and delete unnecessary files.</p> |

**BHT-500B**

## **Chapter 8**

# **Specifications**

This chapter describes the BHT-503B/504BW specifications.

|       |                                     |     |
|-------|-------------------------------------|-----|
| 8.1   | BHT-503B/504BW Specifications ..... | 180 |
| 8.1.1 | Hardware Specifications.....        | 180 |
| 8.1.2 | Barcode Specifications.....         | 181 |
| 8.1.3 | Scanning Performance.....           | 182 |
| 8.1.4 | Interface Specifications .....      | 184 |

# 8.1 BHT-503B/504BW Specifications

## 8.1.1 Hardware Specifications

Power supply (main power): Rechargeable lithium-ion battery cartridge (3.7 V DC)  
 Dimensions (W) x (L) x (H): 48 x 150 x 30 mm  
 Weight: BHT-503B: Approx. 160 g (including battery cartridge BT-50L)  
 BHT-504BW: Approx. 170 g (including battery cartridge BT-50L)  
 Ambient operating temperature: -5° to 50° C  
 Ambient operating humidity: 20 to 80% (with no dew condensation)  
 Ambient operating brightness: 500 to 3,000 Lx.  
 (Depth of field: 400 mm, PCS value: 0.9 min., Reflection intensity: 85% min. for white and 5% max. for black, Narrow bar width: min. 0.125 mm)  
 Controller: CPU: 32-bit RISC  
 Flash memory: BHT-503B: 8 MB  
 BHT-504BW: 16 MB  
 Keypad: Magic keys: 5  
 Function keys: 2  
 Numerical keys etc.: 20  
 Display: Type: Dot-matrix, TFT liquid crystal display (LCD) with backlight  
 Formation: 240 dots wide by 320 dots high

| Font size   |            | Chars x Lines | Dots ( W x H ) |
|-------------|------------|---------------|----------------|
| 40-dot font | Full-width | 6 x 8         | 40 x 40        |
|             | Half-width | 12 x 8        | 20 x 40        |
| 30-dot font | Full-width | 8 x 10        | 30 x 30        |
|             | Half-width | 16 x 10       | 15 x 30        |
| 24-dot font | Full-width | 10 x 13       | 24 x 24        |
|             | Half-width | 20 x 13       | 12 x 24        |
| 16-dot font | Full-width | 15 x 20       | 16 x 16        |
|             | Half-width | 30 x 20       | 8 x 16         |

Calendar clock: Year, month, day, hour, minute, and second  
 Year: 2 digits  
 Auto leap year correction up until 2099  
 Indicator LED: Colors : Red, green and blue

(Note) Some of the pixels on the LCD may not illuminate or stay permanently illuminated. Furthermore, there may also be inconsistencies in color and brightness. None of these aspects represent an LCD defect.

Moreover, there will also be individual differences in visual quality in screens containing the above defects.

## 8.1.2 Barcode Specifications

### Supported Barcode Types

| Barcode Type   | Bar Dimensions | Scan Magnification |
|--|----------------|--------------------|
| Universal product codes  |                |                    |
| EAN-13 (JAN-13)<br>EAN-8 (JAN-8)<br>UPC-A<br>UPC-E<br>EAN-13 (JAN-13) with add-on<br>EAN-8 (JAN-8) with add-on<br>UPC-A with add-on<br>UPC-E with add-on<br>2-digit add-on<br>5-digit add-on | Min. 0.26 mm   | Min. 0.8           |
| Interleaved 2of5 (ITF)<br>Standard 2of5 (STF)<br>Codabar (NW-7)<br>Code 39   | Min. 0.125 mm  |                    |
| Code 93<br>Code 128 (EAN-128)  | Min. 0.15 mm   |                    |
| RSS-14   | Min. 0.15 mm   |                    |
| Composite  | Min. 0.25 mm   |                    |

### Multi-line Codes Scanning

The BHT-503B/504BW supports multi-line codes scanning that scan up to 2 lines of codes out of universal product codes, Interleaved 2of5 (ITF), Codabar (NW-7), Code 39, and Code128 (EAN-128) at a time in the specified order.

The multi-line codes scanning may be specified in user programs only. For details, refer to the "BHT-BASIC Programmer's Manual (BHT-500 Series)."

### Required Optical Properties

White bars: Reflection intensity of 50% or higher

Black bars: Reflection intensity of 10% or lower

PCS value of 0.8 or higher

The reflection intensity is regulated with a light source with spectral peak of 633 nm and spectrum range of 610 to 650 nm.

### 8.1.3 Scanning Performance

#### Scanning Reference Position

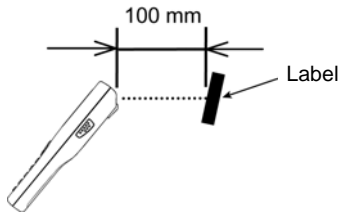

As illustrated at left, align the reading window with the center of the label (code) to be scanned.

#### Scanning Distance and Area

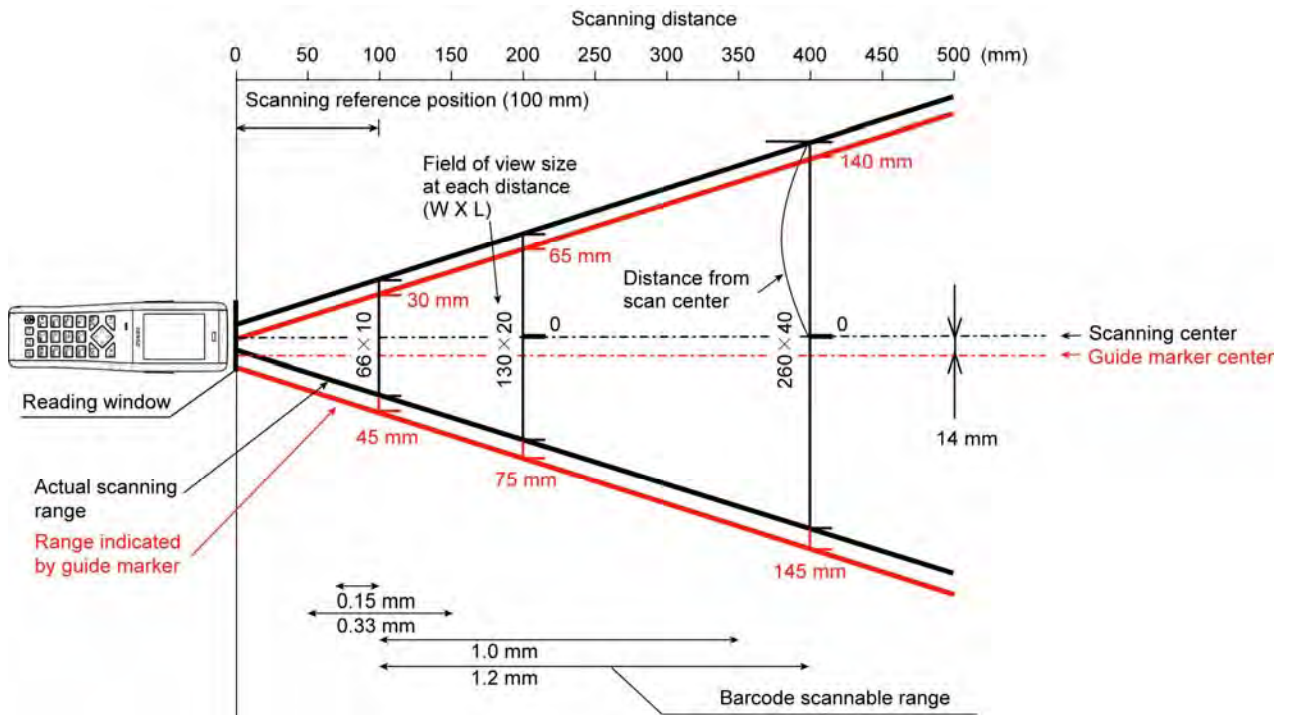

| Minimum Narrow Bar Width | Depth of Field              |
|--------------------------|-----------------------------|
| 0.15 mm                  | 90 to 120 mm <sup>*1</sup>  |
| 0.33 mm                  | 50 to 150 mm <sup>*2</sup>  |
| 1.0 mm                   | 100 to 350 mm <sup>*3</sup> |
| 1.2 mm                   | 100 to 400 mm <sup>*4</sup> |

The label position is on the BHT-503B/504BW central axis.

The BHT-503B/504BW may fail to read codes due to specular reflection depending upon the position of the light source, scanning angle of the reading window, and other conditions.

- \*<sup>1</sup> Under the following conditions:
- Ambient illuminance: 500 Lx. (Fluorescent lamp)
  - Code 39, 15 digits  
Narrow bar: Wide bar = 1 : 2.2
  - Reflection intensity of white bars: 85% min.
  - Reflection intensity of black bars: 5% max.

- \*<sup>3</sup> Under the following conditions:
- Ambient illuminance: 500 Lx. (Fluorescent lamp)
  - ITF conforming to the UPC Shipping Container Code
  - Reflection intensity of white bars: 85% min.
  - Reflection intensity of black bars: 5% max.
  - 1.0 magnifications

- \*<sup>2</sup> Under the following conditions:
- Ambient illuminance: 500 lux. (Fluorescent lamp)
  - EAN-13
  - Reflection intensity of white bars: 85% min.
  - Reflection intensity of black bars: 5% max.
  - 1.0 magnification

- \*<sup>4</sup> Under the following conditions:
- Ambient illuminance: 500 Lx. (Fluorescent lamp)
  - ITF conforming to the UPC Shipping Container Code
  - Reflection intensity of white bars: 85% min.
  - Reflection intensity of black bars: 5% max.
  - 1.2 magnifications



### 8.1.4 Interface Specifications

#### IrDA Interface

Synchronization: Start-stop

Input signals: RD

Output signals: SD

Transmission speed: Max. 460,800 bps

Note: This speed is only possible when communicating from one BHT-503B/504BW unit to another or between the BHT-503B/504BW and CU-521 or BHT-503B/504BW and CU-511. The transmission speed in all other cases is 115,200 bps.

#### Connector Interface

Synchronization: Start-stop

Transmission speed: Max. 115,200 bps

Signal level: Conforms to the RS-232C interface

Pin assignment: As shown below.

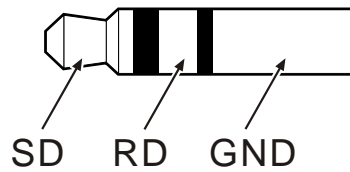

| Pin No. | Signal Name | Function      | Signal Input/Output |                 |
|---------|-------------|---------------|---------------------|-----------------|
|         |             |               | BHT                 | External device |
| 1       | SG (GND)    | Signal ground | —                   | —               |
| 2       | SD          | Send data     | →                   | —               |
| 3       | RD          | Receive data  | ←                   | —               |

#### Wireless Interface (BHT-504BW only)

Specification: IEEE 802.11b/g

Radio type: DS-SS, OFDM

Frequency bands: 2.4 GHz

Data rate: 54/48/36/24/18/12/11/9/6/5.5/2/1 Mbps

Channels: 13 (ETSI)

**BHT-500B**

## **Chapter 9**

# **Appendices**

This chapter describes the CU-500 Series (option) specifications, and describes causes and countermeasures when unable to transfer files.

|       |   |     |
|-------|---|-----|
| 9.1   | CU-500 Specifications .....   | 186 |
| 9.1.1 | Hardware Specifications.....  | 186 |
| 9.1.2 | Charging Requirements (CU-501/521/511) .....                        | 186 |
| 9.1.3 | Interface Specifications .....                                      | 187 |
| 9.2   | When File Transfer is Not Possible Using the Transfer Utility ..... | 189 |

## 9.1 CU-500 Specifications

### 9.1.1 Hardware Specifications

|                                | CU-501                                       | CU-521                           | CU-511                                       |
|--------------------------------|--|----------------------------------|--|
| Power supply:                  | 100/230 V AC<br>(Using dedicated AC adapter) | Powered from the USB interface * | 100/230 V AC<br>(Using dedicated AC adapter) |
| Max. power consumption:        | 6.5 VA                                       | 5V 500 mA                        | 7 VA   |
| Dimensions (W) x (L) x (H):    | 86 x 100 x 57 mm                             | 86 x 94.5 x 57 mm                |  |
| Weight:                        | 105 g  | 100 g                            | 110 g  |
| Ambient operating temperature: | 0 to 40° C                                   |                                  |  |
| Ambient operating humidity:    | 20 to 80% (with no dew condensation)         |                                  |  |

\*The CU-521 can be powered also from the AC adapter.

### 9.1.2 Charging Requirements (CU-501/521/511)

Charge current: Approx. 550 mA (approx. 400 mA \*)

Charge time: Approx. 3 hours (approx. 4 hours \*)

(\*When the CU-521 is powered from the USB host (computer) or USB hub)

### 9.1.3 Interface Specifications

#### CU-501

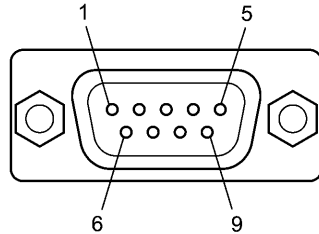

The CU-501 RS-232C interface connector uses Dsub-9P.

| Pin. No. | Signal Name | Function             | Signal Direction<br>CU-501 ↔ External Device |
|----------|-------------|----------------------|--|
| 2        | RD          | Receipt data         | ←  |
| 3        | SD          | Transmission data    | →  |
| 4        | ER          | Data terminal ready  | →  |
| 5        | SG          | Signal ground        | —  |
| 6        | DR          | Data set ready       | —  |
| 7        | RS          | Transmission request | —  |
| 8        | CS          | Transmission ready   | —  |

The CU-501 internal wiring is shown below.

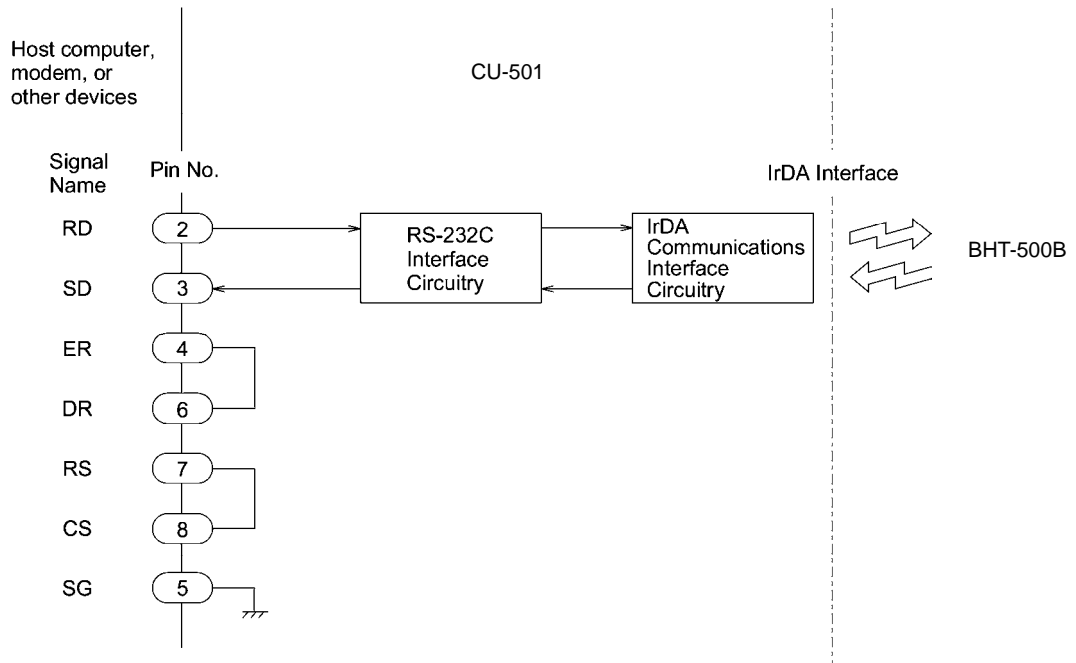

## CU-521

The USB interface on the CU-521 is USB1.1 (Full-speed) compliant, with a Type Mini-B receptacle.

## CU-511

The CU-511 has an IEEE802.3-compliant Ethernet interface port (10base-T).

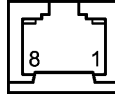

Ethernet Interface Port (RJ45 jack) on the CU-511

| Pin No. | Signal | Functions     |
|---------|--------|---------------|
| 1       | TD+    | Send data     |
| 2       | TD-    | Send data     |
| 3       | RD+    | Receive data  |
| 4       | N.C.   | No connection |
| 5       | N.C.   | No connection |
| 6       | RD-    | Receive data  |
| 7       | N.C.   | No connection |
| 8       | N.C.   | No connection |

## 9.2 When File Transfer is Not Possible Using the Transfer Utility

This section describes the causes and remedies when file transfer is not possible using the Transfer Utility.

| Error No.  | Cause Details  | Remedy   |
|--|--|--|
| 2  | Illegal field information specification option when transmitting data file.                              | Set a correct value for the field information option.  |
|  | The name of the file being downloaded is a long file name.   | Long file names are not supported.<br>Change to an 8.3 format file name.   |
|  | Illegal characters have been used in the file name.  | Change the file name.<br>Refer to QBdirect (page 189, Note 1) for details of characters that can be used in file names.  |
| 3<br>6<br>8  | BHT-Ir/BHT protocol was used for transfer for a BHT-BASIC 4.0 format data file.                          | Use Ymodem protocol or restrict data files to BHT-BASIC 3.6 format.  |
| 51<br>52   | Power is not being supplied to the CU.   | Supply power with an AC adapter or via a USB bus when using a CU with USB connection.  |
|  | Defect or abnormality with the cable between the PC and CU.  | Use a properly functioning RS-232C cross-cable.  |
|  | The DIP switch on the reverse side of the CU have been set incorrectly.                                  | Set the correct transmission speed with the DIP switch on the reverse side of the CU.  |
|  | Defect or abnormality with the USB cable between the PC and CU.  | Use a properly functioning USB cable.  |
|  | Unstable signal wire due to such reasons as a USB cable extension.                                       | Connect directly to a PC USB port or self-powered hub.<br>Connection may not be possible depending on the hub model, and if operation is unstable, connect directly to a PC USB port.  |
|  | The CU can be removed. (The device remains stopped.)   | Disconnect the device and then reconnect.  |
|  | The CU is not recognized by the PC.<br>There is a ! mark at the Device Manager or the device is unknown. | Disconnect the device and then reconnect.<br>If the problem is still not resolved, uninstall the driver and then reinstall.  |
|  | The power supply is insufficient.  | The USB power supply performance may be insufficient depending on the PC model.<br>Furthermore, if another USB device consuming power exceeding the maximum standard (500mA or more) is connected to the adjacent port, insufficient current may be supplied.<br>Use an AC adapter to supply power directly. |
| Defect or abnormality with the cable between the PC and BHT. | Use a properly functioning RS-232C cross-cable.  |  |
| 51<br>52   | The BHT communication interface specification is illegal.  | Specify IrDA(Optical) if connected to the PC via the CU, and Connector if connected via the interface connector. Refer to Qbdirect (page 189, Note 1) for details of the setting method.   |

| Error No. | Cause Details   | Remedy  |
|-----------|---|---|
|           | The Transfer Utility "Communication port" option specification is illegal.  | Specify the communication port to which the BHT is connected for the "Communication port" option.   |
|           | The transmission speed at the BHT and PC does not match.  | Ensure that the transmission speed at the BHT and PC matches.<br>Please be aware that the default transmission speed differs depending on the BHT used.   |
|           | The protocol specified at the BHT and PC does not match.  | Ensure that the protocol matches.<br>Please be aware that the default protocol differs depending on the BHT used.   |
|           | The PC communication port setting is illegal.   | Enable "Use FIFO buffer. (16550 interchangeable UART required.) (U)" setting for the communication port used.   |
|           | Hardware malfunction  | Please contact your dealer.   |
| 53        | The protocol specified at the BHT and PC does not match.  | Ensure that the protocol matches.<br>Please be aware that the default protocol differs depending on the BHT used.   |
| 55        | The protocol specified at the BHT and PC does not match.  | Ensure that the protocol matches.<br>Please be aware that the default protocol differs depending on the BHT used.   |
|           | An attempt was made to download a file with field width differing from that of the data file already existing in the BHT. | It is not possible to download a file with the same name but different field width from the file already existing in the BHT.<br>Either delete the existing data file in the BHT, or specify the same field format as the existing data file. |
| 55<br>71  | Illegal characters have been used in the file name.   | Change the file name.<br>Refer to Qbdirect (page 189, Note 1) for details of characters that can be used in file names.   |
| 75        | The USB-COM port drive has been incorrectly installed.  | Reinstall the USB-COM port driver.  |
| 91        | Illegal field information specification option when transmitting data file.   | Set a correct value for the field information option.   |
| 91        | An attempt was made to download a file with field width differing from that of the data file already existing in the BHT. | It is not possible to download a file with the same name but different field width from the file already existing in the BHT.<br>Either delete the existing data file in the BHT, or specify the same field format as the existing data file. |
|           | The size of the file being downloaded exceeds the size of the available space in the BHT user area.                       | Reduce the file size or delete any unwanted files in the BHT.   |
|           | Illegal characters have been used in the file name.   | Change the file name.<br>Refer to Qbdirect (page 189, Note 1) for details of characters that can be used in file names.   |
| Other     | BHT-Ir/BHT protocol was used for transfer for a BHT-BASIC 4.0 format program file (*.PD4).                                | Use Ymodem protocol or convert program files to "*.PD3".  |

| Error No. | Cause Details  | Remedy  |
|-----------|--|---|
|           | An attempt was made to download a BHT-BASIC 3.6 format program file (*.PD3). | Use BHT-BASIC 4.0 format program files (*.PD4). |

Note 1: "Customer Registration" is required to use Qbdirect (free of charge).

When using for the first time, complete "Customer Registration" and then refer to the following procedure to use Qbdirect.

Refer to "Customer Registration" on page ii.

- (1) Click the QBdirect URL below.
- (2) Enter your user ID and password to log in.
- (3) Click "FAQ".
- (4) Specify the search method and perform search.

<http://www.qbdirect.net>



Barcode Handy Terminal

BHT-500B

---

User's Manual

First Edition May 2008  
Second Edition March 2010

---

DENSO WAVE INCORPORATED